

aresline

Comfortable
experiences
for workplaces,
waiting,
educational
and training
rooms.

Seating Collection

aresline

Comfortable
experiences
for workplaces,
waiting,
educational
and training
rooms.

IT – Esperienze
di comfort per spazi
di lavoro, attesa,
aule per la didattica
e la formazione.

FR – Expériences
de confort pour
les espaces de travail
et d'accueil, et pour
les salles dédiées
à l'enseignement
et à la formation.

DE – Bequeme
Erlebniswelten
für Arbeitsplätze,
Warte-, Schulungs-
und Trainingsräume.

ES – Experiencias
confortables para
espacios de trabajo,
aulas educativas
y salas de espera.

aresline

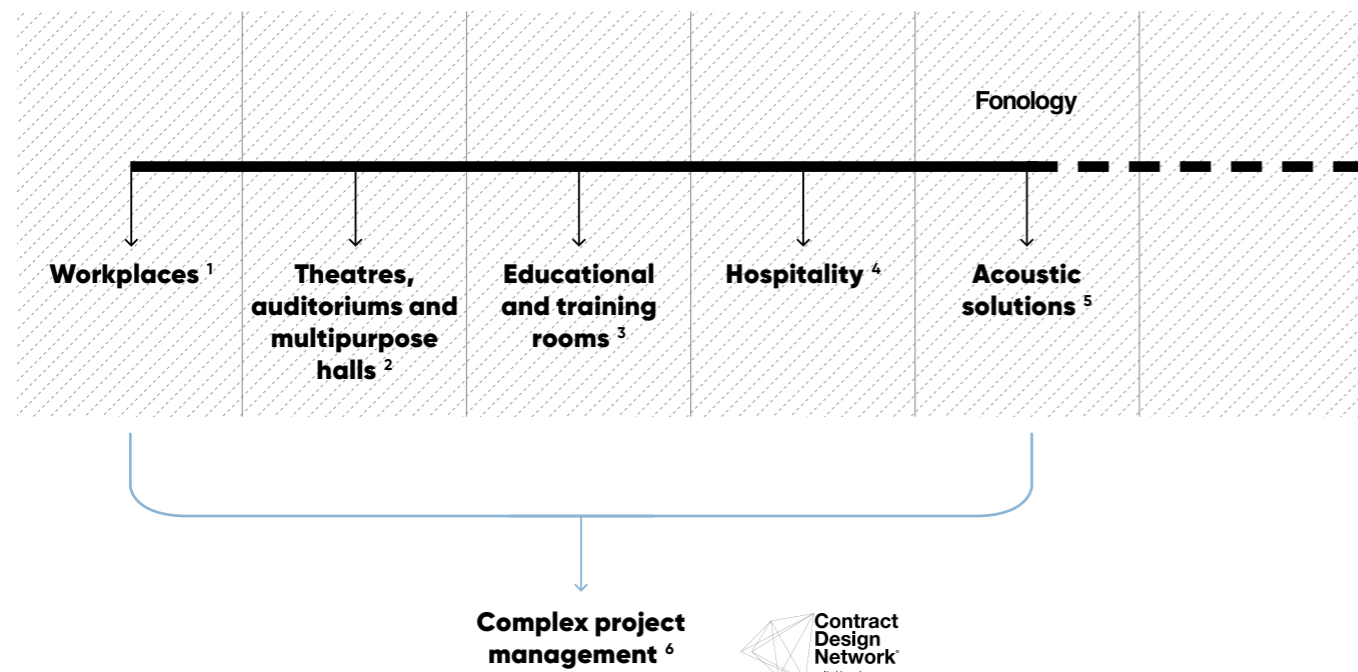

IT

- 1 Spazi di lavoro.
- 2 Teatri, centri congressi e sale polivalenti.
- 3 Aule per la didattica e la formazione.
- 4 Spazi per l'ospitalità.
- 5 Soluzioni acustiche.
- 6 Gestione progetti complessi.

FR

- 1 Espaces de travail.
- 2 Théâtres, centres de congrès et salles polyvalentes.
- 3 Salles pour l'enseignement et la formation.
- 4 Espaces d'accueil.
- 5 Solutions acoustiques.
- 6 Gestion de projets complexes.

DE

- 1 Arbeitsräume.
- 2 Theater, Kongresszentren und Mehrzweckhallen.
- 3 Lehr- und Ausbildungsräume.
- 4 Gastronomiebereiche.
- 5 Akustische Lösungen.
- 6 Management komplexer Projekte.

ES

- 1 Espacios de trabajo.
- 2 Teatros, centros de congresos y salas polivalentes.
- 3 Aulas de enseñanza y formación.
- 4 Espacios de recepción.
- 5 Soluciones acústicas.
- 6 Gestión de proyectos complejos.

IT – Le nostre competenze ci consentono di avere e offrire una visione strategica trasversale a diversi ambiti.

FR – Nos compétences nous permettent d'avoir et d'offrir une vision stratégique transversale des différents espaces.

DE – Wir verfolgen eine zielgerichtete Vision, die wir aufgrund unserer Erfahrungen in verschiedenen Bereichen umsetzen können.

ES – Nuestros conocimientos nos permiten tener y ofrecer una visión estratégica que abarca diferentes ámbitos.

Thanks to our skills, we have and can offer a broad strategic vision relevant to diverse contexts.

Values

In various fields of expertise and at every stage of the production process, our guiding principle is the pursuit of excellence.

IT – Ricercare l'eccellenza, nei diversi settori di competenza e in ogni fase del processo produttivo è il nostro modo di essere.

FR – Notre façon d'être peut se résumer ainsi : recherche de l'excellence, dans les différents secteurs de compétence et à chaque phase du processus de production.

DE – Wir streben nach Höchstleistungen in den verschiedenen Leistungsbereichen und in jeder Phase des Produktionsprozesses. So verstehen wir uns.

ES – Buscar la excelencia en los diferentes sectores de competencia y en cada fase del proceso de producción es nuestra forma de ser.

Ecology

We dedicate a great deal of attention to every element of the production chain, so that it is eco-sustainable and part of a circular economy.

IT – Ecologia

Prestiamo attenzione ad ogni elemento della filiera produttiva, affinché sia ecosostenibile e rientri nel flusso di un'economia circolare.

FR – Écologie

Nous sommes attentifs à chaque élément de la filière de production, afin qu'elle soit éco-durable et qu'elle s'intègre dans le schéma de l'économie circulaire.

DE – Ökologie

Wir achten darauf, dass jedes Element der Produktionskette umweltverträglich und Teil des ökonomischen Kreislaufs ist.

ES – Ecología

Prestamos atención a todos los elementos de la cadena de producción, de manera que sea sostenible con el medio ambiente y se integre en el flujo de una economía circular.

Research

We invest to continuously improve our products: this is why we joined the ILP of MIT in Boston.

IT – Ricerca

Investiamo per migliorare continuamente i nostri prodotti: per questo abbiamo aderito all'ILP del MIT di Boston.

FR – Recherche

Nous investissons pour améliorer sans cesse nos produits : c'est pourquoi nous avons adhéré à l'Industrial Liaison Program (ILP) du MIT de Boston.

DE – Forschung

Wir engagieren uns für die kontinuierliche Verbesserung unserer Produkte und aus diesem Grund haben wir uns dem ILP der MIT in Boston angeschlossen.

ES – Investigación

Invertimos en la mejora continua de nuestros productos, por lo que nos hemos adherido al Industrial Liaison Program (ILP) del Instituto Tecnológico de Massachusetts (MIT).

Network

We build a network of complementary experiences and skills, allowing us to tackle complex project management.

IT – Rete

Facciamo rete con esperienze e competenze complementari per affrontare progetti complessi.

FR – Réseau

Nous formons un réseau avec des expériences et des compétences complémentaires pour aborder la gestion de projets complexes.

DE – Netzwerk

Um das Management komplexer Projekte zu realisieren, nutzen wir ergänzende Erfahrungen und Kompetenzen aus unserem Netzwerk.

ES – Red

Formamos una red con experiencia y conocimientos complementarios para abordar proyectos complejos.

Quality

We believe that the knowledge and professionalism of a region's people are an important asset for creating recognisable and certified quality.

IT – Qualità

Crediamo che il sapere e la professionalità delle persone di un territorio siano un patrimonio importante per creare una qualità riconoscibile e certificata.

FR – Qualité

Nous sommes convaincus que le savoir et le professionnalisme des personnes d'un territoire sont un patrimoine important pour créer une qualité reconnue et certifiée.

DE – Qualität

Wir glauben, dass das Fachwissen und die Professionalität der Mitarbeiter eines bestimmten Gebietes entscheidend sind, um erkennbare und zertifizierte Qualität zu schaffen.

ES – Calidad

Creemos que el conocimiento y la profesionalidad de las personas de un territorio son un valioso tesoro que nos permite crear una calidad reconocida y certificada.



IT – Al sapere delle nostre mani abbiamo affiancato competenze tecniche specializzate.

FR – À notre savoir manuel, nous avons ajouté des compétences techniques spécialisées.

DE – Neben den handwerklichen Fertigkeiten haben wir auch spezielle technische Fähigkeiten entwickelt.

ES – Al saber hacer de nuestras manos, hemos sumado habilidades técnicas especializadas.

IT – La stampante 3D ci consente di sviluppare i prodotti in maniera puntuale e in tempi ridotti.

La prototipazione rapida rientra nel percorso industria 4.0 di ingegnerizzazione del processo per una gestione controllata.

FR – L'imprimante 3D nous permet de développer les produits en étant ponctuels et dans des délais réduits.

La prototypisation rapide fait partie du parcours industrie 4.0 de programmation du processus pour une gestion contrôlée.

DE – Der 3D-Druck ermöglicht es uns, Produkte zeitgerecht und in kurzer Zeit zu entwickeln.

Die schnelle Prototypenerstellung ist Teil des verfahrenstechnischen Prozesses Industrie 4.0 für ein kontrolliertes Management.

ES – La impresión en 3D nos permite desarrollar productos de forma puntual y reduciendo los plazos de entrega.

La creación rápida de prototipos se enmarca en el ámbito de la Industria 4.0 de programación de la producción para conseguir una gestión controlada.

We have combined our manual skills with specialised technical knowledge.

3D printing lets us develop products quickly and efficiently.

Rapid prototyping is one facet of industry 4.0 process engineering for controlled management.

Certifications

The quality and safety of our company and products are guaranteed by certified third-party organisations.

IT – La nostra qualità, la sicurezza dell'azienda e dei nostri prodotti sono attestate da enti terzi certificati.

FR – La qualité et la sécurité de l'entreprise et de nos produits sont attestées par des organismes tiers certifiés.

DE – Unsere Qualität, die Sicherheit unseres Unternehmens und unserer Produkte werden durch zerti-fizierte Drittunterneh-men bestätigt.

ES – Nuestra calidad, la seguridad de nuestra empresa y de nues-tros productos están avalados por entidades externas certificadas.

Each product has a value-added feature. All our products and processes are certified.

IT – Valore aggiunto in ogni singolo prodotto. Certifichiamo tutto quello che facciamo e come lo facciamo.

FR – Une valeur supplémentaire dans chaque produit. Nous certifions tout ce que nous faisons et comment nous le faisons.

DE – Zusätzliche Werte in jedem einzelnen Produkt. Wir zertifizieren alle Produkte und alle Herstellungsverfahren.

ES – Valor añadido en cada producto. Certificamos todo lo que hacemos y cómo lo hacemos.



Company

IT – Aziendali
FR – De l'entreprise
DE – Betrieblich
ES – Corporativas



IT – Prodotto
FR – Produit
DE – Produkt
ES – Producto

Product



Indice

Office

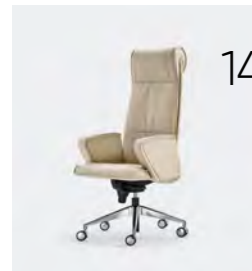

14

Parlament

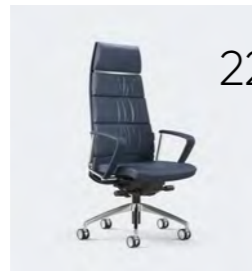

22

Trendy Family



38

Amadeus

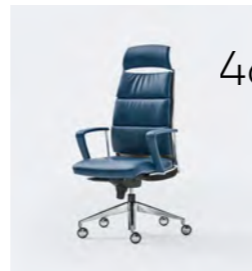

46

Link Family

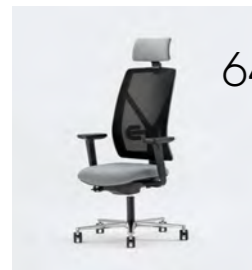

64

Dotway

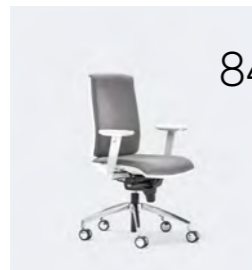

84

Zero7 Family

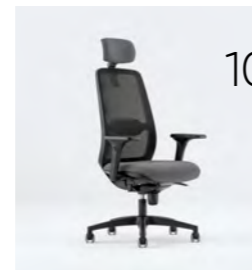

108

Paddle

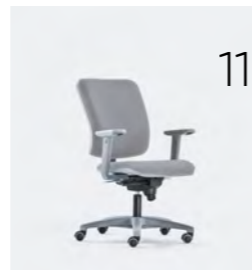

118

Smart

Waiting

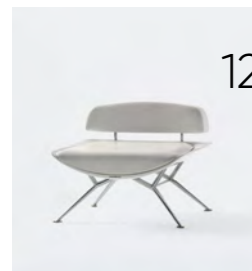

126

PF3



134

Naxos



144

Mya



152

Jolly



162

Ventuno

Acoustic



174

Naxos Acoustic



186

Privée



196

Base



208

Prà

Multipurpose

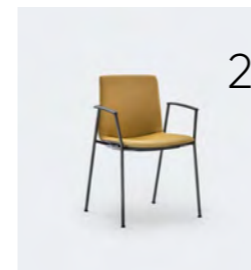

218

Aira



252

Papillon Family



264

Eura Family



278

Zero9 Family



308

Woody



320

Omnia Contract



328

Hip-Up Family

Office

Parlament – p. 14

Trendy Family – p. 22

Amadeus – p. 38

Link Family – p. 46

Dotway Family – p. 64

Zero7 Family – p. 84

Paddle – p. 108

Smart – p. 118

Parlament



BaccolinDesign



Parlament

mod. 5015

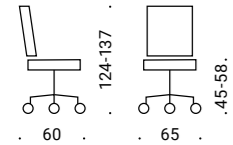

mod. 5015

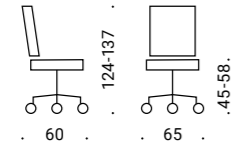
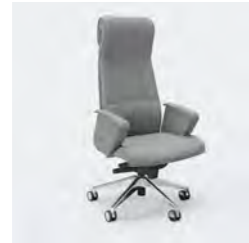

mod. 5045

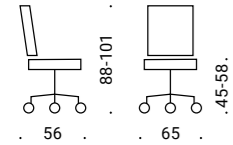

mod. 5045

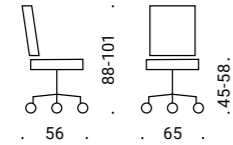
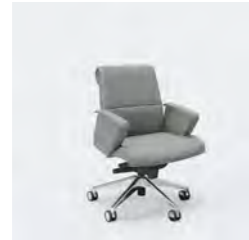

mod. 5045R

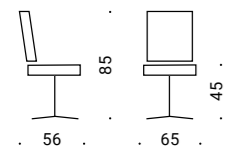

mod. 5045R

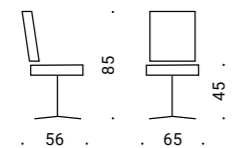

Models



Parlament



EN

Materials

– Seat and backrest in beech plywood padded with flexible differentiated-density self-extinguishing polyurethane.

Backrest types

– High with headrest.
– Low.

Armrests

– Closed in birch plywood with upholstery and fixed to a steel support.
– Open in black integral skin polyurethane.
– Open with chromed steel frame and finished with black integral skin polyurethane.
– Open with chromed steel frame and surfacing. *Always with "soft touch" elastomer upholstery.*

Base types

– Four-spoke base in polished aluminium with nylon feet.
– Five-spoke base in nylon or polished aluminium with castors or fixed feet. Self-braking swivel castors made of nylon with polyurethane tread. Fixed feet in nylon.

Mechanisms

– Seat height adjustment with gas cylinder.
– Lumbar support height adjustment.
– Seat tilt with Synchron multiblock mechanism, Synchron multiblock with adjustable seat depth, Synchron multiblock with adjustable seat depth and forward tilt, all with multi-position locking, tilt adjustment, and anti-return safety system.

Optional accessories

– Contrasting stitching. **(1)**
– Seat cushion with integrated micro-springs. **(2)**

IT

Materiali

– Sedile e schienale in legno multistrato di faggio con imbottitura in poliuretano flessibile autoestinguenta a densità differenziata.

Tipologie di schienale

– Alto con poggiatesta.
– Basso.

Braccioli

– Chiusi in legno multistrato di betulla con rivestimento e fissati su supporto d'acciaio.
– Aperti in poliuretano integrale autopellante nero.
– Aperti con struttura in acciaio cromato e finitura in poliuretano integrale autopellante nero.
– Aperti con struttura in acciaio cromato e rivestimento. *Sempre con*

copertura in elastomero "soft touch".

Tipologie di base

– Base a quattro razze in alluminio lucidato con piedini in nylon.
– Base a cinque razze in nylon o alluminio lucidato con ruote o piedini fissi. Le ruote piroettanti autofrenanti sono in nylon con battistrada in poliuretano. I piedini fissi sono in nylon.

Meccanismi

– Regolazione in altezza della seduta con pompa a gas.
– Regolazione in altezza del supporto lombare.
– Oscillazione della poltrona con movimenti sincron multiblock, sincron multiblock con regolazione della profondità del sedile, sincron multiblock con regolazione in profondità e dell'assetto in negativo del sedile, tutti con bloccaggio in più posizioni, regolazione dell'oscillazione e sistema di sicurezza anti-ritorno.

Accessori opzionali

– Cuciture a contrasto. **(1)**
– Cuscino sedile con micromolle integrate. **(2)**

FR

Matériaux

– Assise et dossier en bois de hêtre multiplis avec rembourrage en polyuréthane flexible autoextinguible à densité différenciée.

Types de dossier

– Haut avec appuie-tête.
– Bas.

Accoudoirs

– Fermés en bois de bouleau multiplis avec revêtement et fixés sur support en acier.
– Ouverts en polyuréthane intégral noir.
– Ouverts avec structure en acier chromé et finition en polyuréthane intégral noir.
– Ouverts avec structure en acier chromé et revêtement. *Toujours avec manchette d'appui confort en élastomère « soft touch ».*

Types de piètement

– Piètement à quatre branches en aluminium poli avec pieds en nylon.
– Piètement à cinq branches en nylon ou aluminium poli avec roulettes ou pieds fixes. Les roulettes pivotantes autofreinantes sont en nylon avec chape en polyuréthane.
Les pieds fixes sont en nylon.

Mécanismes

– Réglage en hauteur du siège avec vérin à gaz.
– Réglage en hauteur du soutien lombaire.

– Oscillation du fauteuil avec des mouvements mécanisme synchrone multiblock, mécanisme synchrone multiblock avec réglage de la profondeur de l'assise, mécanisme synchrone multiblock avec réglage de la profondeur et mécanisme d'assise négative, tous avec blocage possible dans plusieurs positions, réglage de l'oscillation et système de sécurité anti-retour.

Accessoires en option

– Couture contrastée. **(1)**
– Coussin assise avec micro-ressorts intégrés. **(2)**

DE

Materialien

– Sitz und Rückenlehne aus Buchensperholz mit flexibler, selbstverlöschender Polyurethan-Polsterung in unterschiedlicher Stärke.

Typen von Rückenlehnen

– Hoch mit Kopfteil.
– Niedrig.

Armlehnen

– Geschlossen aus beschichtetem Birkensperholz und auf einem Stahlträger befestigt.
– Offen aus reißfestem, schwarzem Integral-Polyurethan.
– Offen mit verchromtem Stahlrahmen und einem Finish aus schwarzem, reißfestem Integral-Polyurethan.
– Offen mit verchromtem Stahlrahmen und Bezug. *Immer mit „soft touch“-Gummierung.*

Grundmodelle

– Vierarmiges Fußkreuz aus poliertem Aluminium mit Nylonfüßen.
– Fünfarmiges Fußkreuz aus Nylon oder poliertem Aluminium mit Rollen oder festen Standfüßen. Die selbstbremsenden Schwenkräder bestehen aus Nylon mit Polyurethan-Lauffläche. Die festen Standfüße bestehen aus Nylon.

Funktionen

– Sitzhöhenverstellung mit Gasdruckfeder.
– Höhenverstellung der Lendenwirbelstütze.
– Drehbarer Sitz mit synchronen Multiblock-Bewegungen, einem synchronen Multiblock mit Sitztiefenverstellung, einem synchronen Multiblock mit Tiefenverstellung und einer negativen Sitzneigung, alle verfügen über eine Verriegelung in mehreren Positionen, eine Schwingungsverstellung und ein Sicherheits-Rückschwingsperresystem.

Sonderzubehörteile

– Kontrastnähte. **(1)**
– Sitzpolster mit integrierten Mikrofedern. **(2)**

ES

Materiales

– Asiento y respaldo de madera multicapa de haya con acolchado de poliuretano flexible autoextinguible de diferentes densidades.

Tipos de respaldo

– Alto con reposacabezas.
– Bajo.

Brazos

– Cerrados, en multicapa de abedul, tapizados y fijados sobre soporte de acero.
– Abiertos, de poliuretano de piel integral negro.
– Abiertos, con estructura de acero cromado y acabado en poliuretano de piel integral negro.
– Abiertos, con estructura de acero cromado y tapizados. *Siempre con cubierta de elastómero «soft touch».*

Tipos de base

– Base de cuatro radios de aluminio pulido con pies de nailon.
– Base de cinco radios de nailon o aluminio pulido con ruedas o pies fijos. Las ruedas pivotantes autofrenantes son de nailon con banda de rodadura en poliuretano. Los pies fijos son de nailon.

Mecanismos

– Altura del asiento regulable con pistón a gas.
– Altura del soporte lumbar regulable.
– Oscilación de la silla con movimientos sincron multiblock, sincron multiblock con ajuste de profundidad del asiento, sincron multiblock con ajuste de profundidad del asiento y con inclinación negativa, todos con bloqueo en diferentes posiciones, regulación de la oscilación y sistema de seguridad antirretorno.

Accesorios opcionales

– Costuras en contraste. **(1)**
– Cojín del asiento con micromuelles integrados. **(2)**

1



2



EN – Warranty IT – Garanzia
FR – Garantie DE – Garantie
ES – Garantía

Trendy Family

Trendy First Class



BaccolinDesign

Trendy



Trendy Family

mod. 5215

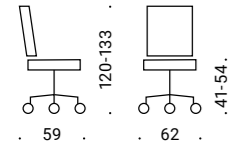

mod. 5213

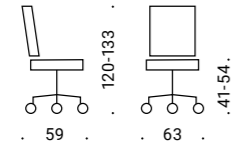

mod. 5218

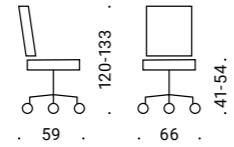

mod. 5235

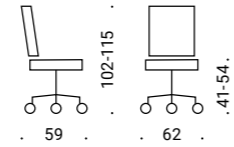

mod. 5233

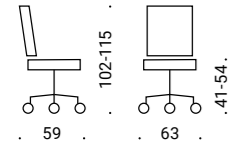

mod. 5238

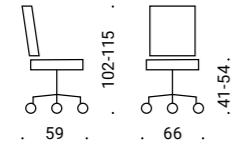

mod. 5231

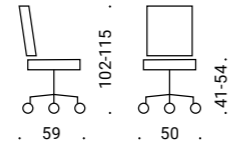

mod. 5235S

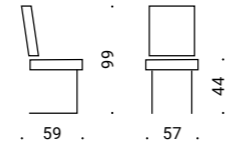

mod. 5245R

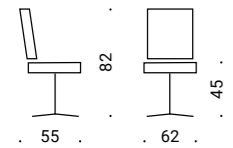
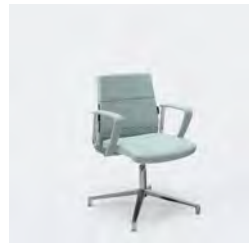

mod. 5241R

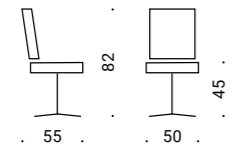
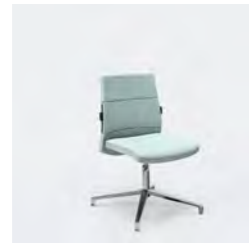

mod. 5245B

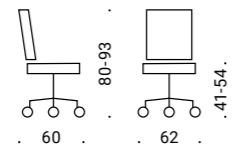

mod. 5241B

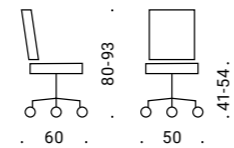

Models

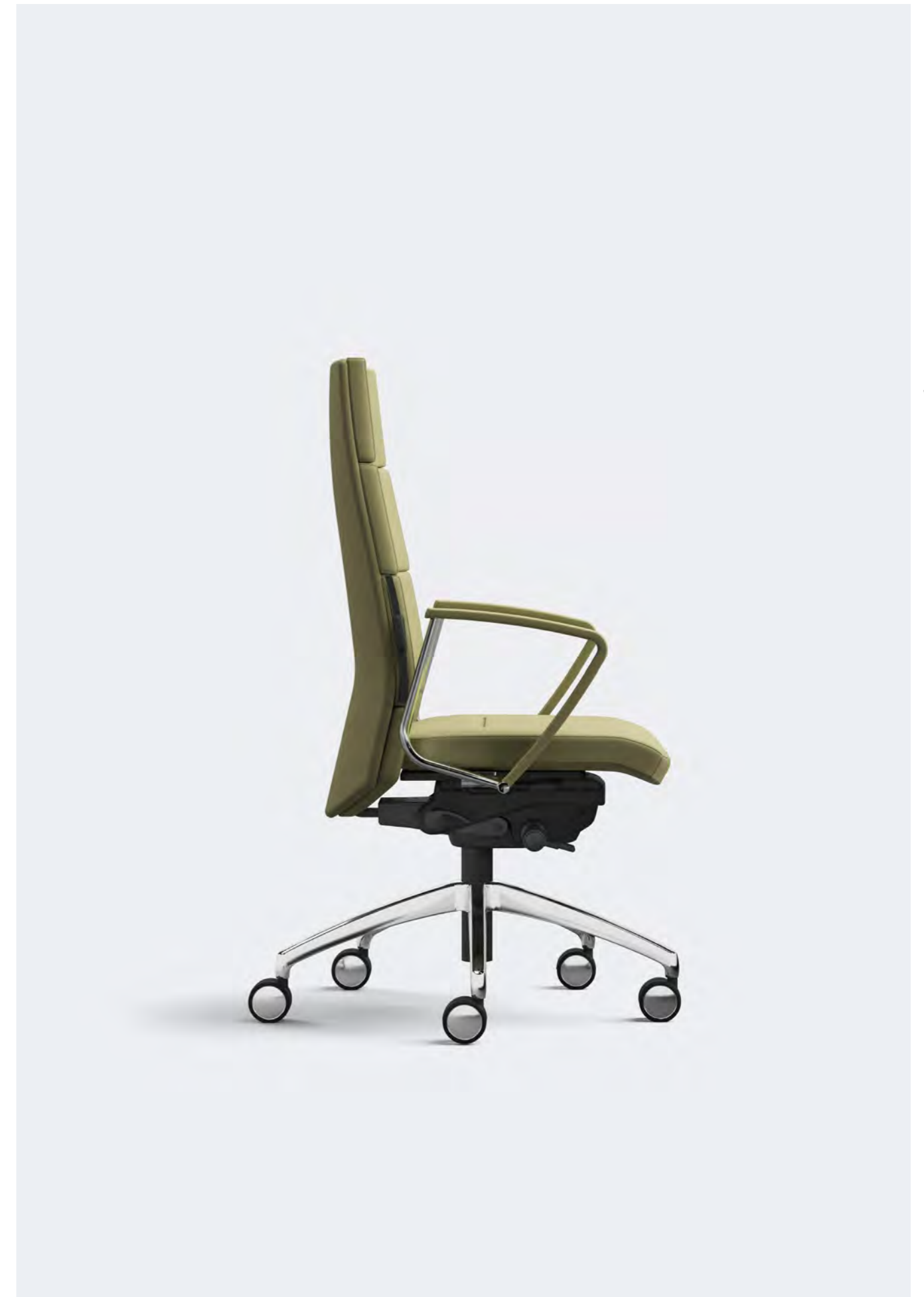

Trendy First Class





mod. 5315

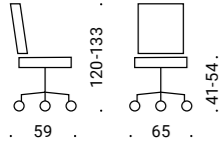

mod. 5313

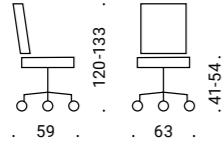

mod. 5318

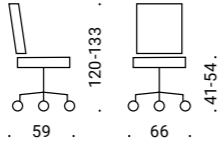

mod. 5335

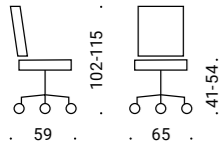

mod. 5333

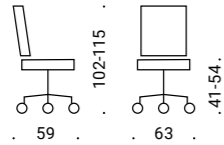

mod. 5338

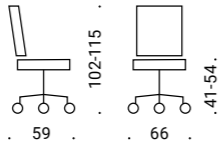

mod. 5331

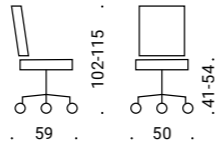

mod. 5335S

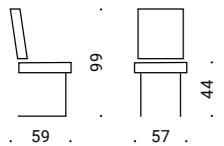

Models



Trendy

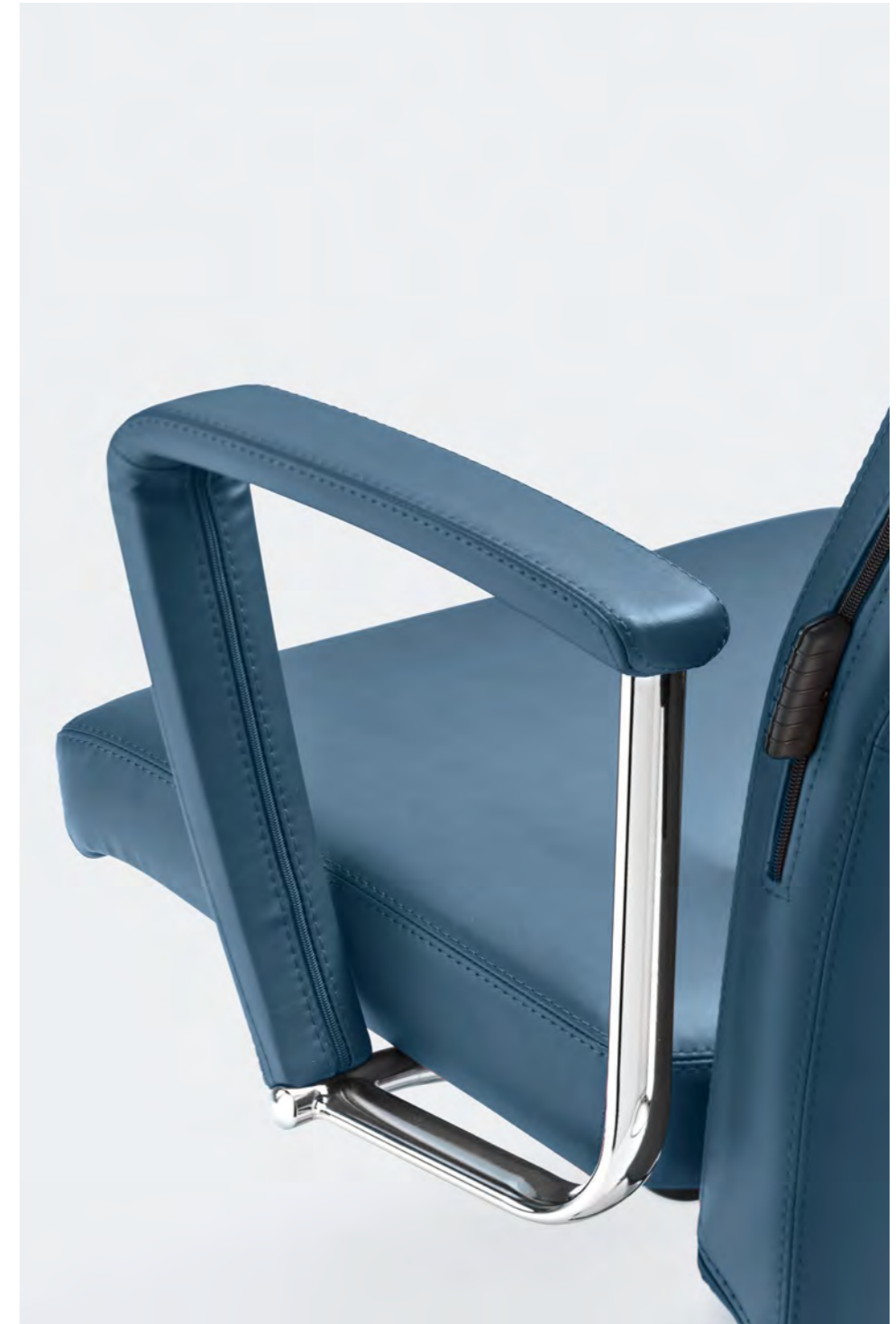



EN

Materials*All models*

– Seat, backrest and headrest (if present) in beech plywood with padding in flexible self-extinguishing differential-density polyurethane. Ergonomic lumbar support in polypropylene.

Types of backrest*All models*

– High with headrest.
– Medium.

Trendy First Class

– Also available with low back.

Base types*All models*

– Sled base in asform tubular steel, powder coated or chromed.
– Five-spoke base in nylon or polished aluminium, with castors or fixed feet. Self-braking swivel castors made of nylon with polyurethane tread. Fixed feet in nylon.

Trendy First Class

– Also available with four-spoke base in polished aluminium.

Mechanisms*All models*

– Seat height adjustment with gas cylinder.
– Lumbar support height adjustment.
– Seat tilt with Synchron multiblock mechanism, Synchron multiblock with adjustable seat depth, Synchron multiblock with adjustable seat depth and forward tilt, all with multi-position locking, tilt adjustment, and anti-return safety system.

Optional accessories*All models*

– Fixed armrests in black integral skin polyurethane.
– Fixed armrests with chromed steel frame and upper surface finish in black integral skin polyurethane.
– Fixed armrests with chromed steel frame and upholstery.
– Adjustable 2D armrests with chromed steel frame and upper surface finish in polypropylene.
– Adjustable 2D armrests with chromed steel frame and upholstery.
– Polypropylene adjustable armrests in 4D version. *Always with "soft touch" elastomer upholstery. (1-4)*
– Seat cushion with integrated micro-springs. (5)

IT

Materiali*Tutti i modelli*

– Sedile e schienale in legno multistrato di faggio con imbottitura in poliuretano flessibile autoestinguente a densità differenziata. Supporto lombare ergonomico in polipropilene.

Tipologie di schienale*Tutti i modelli*

– Alto con poggiatesta.
– Medio.

Trendy First Class

– Disponibile anche con schienale basso.

Tipologie di base*Tutti i modelli*

– Base a slitta in tubolare di acciaio asform verniciato a polvere o cromato.
– Base a cinque razze in nylon o alluminio lucidato, con ruote o piedini fissi. Le ruote piroettanti autofrenanti sono in nylon con battistrada in poliuretano. I piedini fissi sono in nylon.

Trendy First Class

– Disponibile anche con base a quattro razze in alluminio lucidato con piedini in nylon.

Meccanismi*Tutti i modelli*

– Regolazione in altezza della seduta con pompa a gas.
– Regolazione in altezza del supporto lombare.
– Oscillazione della poltrona con movimenti sincron multiblock, sincron multiblock con regolazione della profondità del sedile, sincron multiblock con regolazione in profondità e dell'assetto in negativo del sedile, tutti con bloccaggio in più posizioni, regolazione dell'oscillazione e sistema di sicurezza anti-ritorno.

Accessori opzionali*Tutti i modelli*

– Braccioli fissi in poliuretano integrale autopellante nero.
– Braccioli fissi con struttura in acciaio cromato e finitura superiore in poliuretano integrale autopellante nero.
– Braccioli fissi con struttura in acciaio cromato e rivestimento.
– Braccioli regolabili 2D con struttura in acciaio cromata e finitura superiore in polipropilene.
– Braccioli regolabili 2D con struttura in acciaio cromata e rivestimento.
– Braccioli regolabili in polipropilene in versione 4D. *Sempre con copertura in elastomero "soft touch". (1-4)*
– Cuscino sedile con micromolle integrate. (5)

FR

Matériaux*Tous les modèles*

– Assise, dossier et éventuel appuie-tête en bois de hêtre multiplis avec rembourrage en polyuréthane flexible autoextinguible à densité différenciée. Soutien lombaire ergonomique en polypropylène.

Types de dossier*Tous les modèles*

– Haut avec appuie-tête.
– Moyen.

Trendy First Class

– Également disponible avec dossier bas.

Types de piètement*Tous les modèles*

– Piètement luge en tubes d'acier asform verni à poudre ou chromé.
– Piètement à cinq branches en nylon ou aluminium poli, avec roulettes ou pieds fixes. Les roulettes pivotantes autofreinantes sont en nylon avec chape en polyuréthane.
Les pieds fixes sont en nylon.

Trendy First Class

– Également disponible avec piètement à quatre branches en aluminium poli.

Mécanismes*Tous les modèles*

– Réglage en hauteur du siège avec vérin à gaz.
– Réglage en hauteur du soutien lombaire.
– Oscillation du fauteuil avec des mouvements mécanisme synchrone multiblock, mécanisme synchrone multiblock avec réglage de la profondeur de l'assise, mécanisme synchrone multiblock avec réglage de la profondeur et mécanisme d'assise négative, tous avec blocage possible dans plusieurs positions, réglage de l'oscillation et système de sécurité anti-retour.

Accessoires en option*Tous les modèles*

– Accoudoirs fixes en polyuréthane intégral noir.
– Accoudoirs fixes avec structure en acier chromé et finition supérieure en polyuréthane intégral noir.
– Accoudoirs fixes avec structure en acier chromé et revêtement.
– Accoudoirs réglables 2D avec structure en acier chromé et finition supérieure en polypropylène.
– Accoudoirs réglables 2D avec structure en acier chromé et revêtement.
– Accoudoirs réglables en polypropylène en version 4D. *Toujours avec manchette d'appui confort en élastomère « soft touch ». (1-4)*
– Coussin assise avec micro-ressorts intégrés. (5)

DE

Materialien*Alle Modelle*

– Sitz, Rückenlehne und eventuelle Kopfstütze aus Buchensperrholz mit flexibler, selbstverlöschender Polyurethan-Polsterung in unterschiedlicher Stärke. Ergonomische Lendenwirbelstütze aus Polypropylen.

Typen von Rückenlehnen*Alle Modelle*

– Hoch mit Kopfteil.
– Mittel.

Trendy First Class

– Auch mit niedriger Rückenlehne erhältlich.

Grundmodelle*Alle Modelle*

– Kufengestell aus pulverbeschichtetem oder verchromtem Asform-Stahlrohr.
– Fünfarmiges Fußkreuz aus Nylon oder poliertem Aluminium mit Rollen oder festen Standfüßen. Die selbstbremsenden Schwenkräder bestehen aus Nylon mit Polyurethan-Lauffläche. Die festen Standfüße bestehen aus Nylon.

Trendy First Class

– Auch mit Vierarmiges Fußkreuz aus poliertem Aluminium erhältlich.

Funktionen*Alle Modelle*

– Sitzhöhenverstellung mit Gasdruckfeder.
– Höhenverstellung der Lendenwirbelstütze.
– Drehbarer Sitz mit synchronen Multiblock-Bewegungen, einem synchronen Multiblock mit Sitztiefenverstellung, einem synchronen Multiblock mit Tiefenverstellung und einer negativen Sitzneigung, alle verfügen über eine Verriegelung in mehreren Positionen, eine Schwingungsverstellung und ein Sicherheits-Rückschwingsperrsystem.

Sonderzubehörteile*Alle Modelle*

– Armlehnen: fest aus reißfestem, schwarzem Integral-Polyurethan.
– Armlehnen: fest mit verchromtem Stahlrahmen und einem hochwertigen Finish aus schwarzem, reißfestem Integral Polyurethan.



EN – Warranty IT – Garanzia
FR – Garantie DE – Garantie
ES – Garantía

– Armlehnen: fest mit verchromtem Stahlrahmen und Bezug.
– Armlehnen: in zwei Ebenen verstellbar mit verchromtem Stahlrahmen und einem Finish aus Polypropylen.
– Armlehnen: in zwei Ebenen verstellbar mit verchromtem Stahlrahmen und Bezug.
– Armlehnen: in vier Ebenen verstellbar aus Polypropylen. *Immer mit „soft touch“-Gummierung. (1-4)*
– Sitzpolster mit integrierten Mikrofedern. (5)

ES

Materiales*Todos los modelos*

– Asiento, respaldo y reposacabezas (si lo hubiera) en multicapa de haya con acolchado de poliuretano flexible autoextinguible de diferentes densidades. Soporte lumbar ergonómico de polipropileno.

Tipos de respaldo*Todos los modelos*

– Alto con reposacabezas.
– Mediano.

Trendy First Class

– También disponible con respaldo bajo.

Tipos de base*Todos los modelos*

– Base de patín en tubular de acero asform pintado con polvo o cromado.
– Base de cinco radios de nailon o aluminio pulido con ruedas o pies fijos. Las ruedas pivotantes autofrenantes son de nailon con banda de rodadura en poliuretano. Los pies fijos son de nailon.

Trendy First Class

– También disponible con base de cuatro radios de aluminio pulido.

Mecanismos*Todos los modelos*

– Altura del asiento regulable con pistón a gas.
– Altura del soporte lumbar regulable.
– Oscilación de la silla con movimientos sincron multiblock, sincron multiblock con ajuste de profundidad del asiento y con inclinación negativa, todos con bloqueo en diferentes posiciones, regulación de la oscilación y sistema de seguridad antirretorno.

Accesorios opcionales*Todos los modelos*

– Brazos fijos de poliuretano de piel integral negro.
– Brazos fijos con estructura de acero cromado y acabado superior de poliuretano de piel integral negro.
– Brazos fijos con estructura de acero cromado y tapizados.

– Brazos regulables en 2D con estructura de acero cromado y acabado superior de polipropileno.
– Brazos regulables en 2D con estructura de acero cromado y tapizados.
– Brazos regulables de polipropileno en versión 4D. *Sempre con cubierta de elastómero «soft touch». (1-4)*
– Cojín del asiento con micromuelles integrados. (5)



Amadeus



BaccoliniDesign



Amadeus

mod. 8315

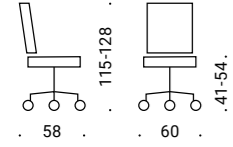
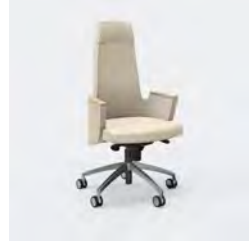

mod. 8215

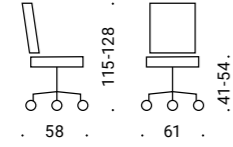
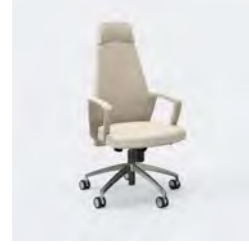

mod. 8335B

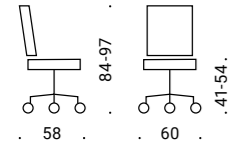

mod. 8335R

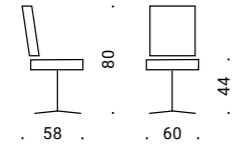
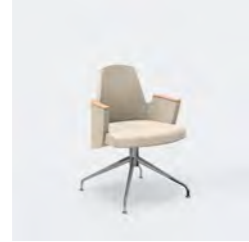

mod. 8335C

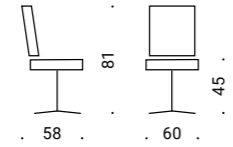

Models



Amadeus



EN

Materials

– Seat in birch plywood and backrest in tubular steel with padding in self-extinguishing cold-moulded polyurethane foam.

Types of backrest

– High with headrest.
– Low.

Armrests

– Closed and integrated with the backrest, in varnished beech or upholstered.
– Open in integral skin polyurethane with steel insert or upholstered. **(1)**

Base types

– Four-leg base in tubular chromed steel with adjustable feet.
– Steel disk base surfaced with stainless steel, free swivel or automatic return swivel.
– Five-spoke base in polished aluminium, with castors or fixed feet. Self-braking swivel castors made of nylon with polyurethane tread. Fixed feet in nylon.

Mechanisms

– Seat height adjustment with gas cylinder.
– Seat tilt with Synchron multiblock mechanism with tilt adjustment, and anti-return safety system.

IT

Materiali

– Sedile in legno multistrato di betulla e schienale in tubolare d'acciaio con imbottitura in poliuretano autoestingente schiumato a freddo.

Tipologie di schienale

– Alto con poggiatesta.
– Basso.

Braccioli

– Chiusi e integrati allo schienale, con finitura superiore in faggio verniciato o rivestiti.
– Aperti in poliuretano integrale autopellante con inserto in acciaio o rivestiti. **(1)**

Tipologie di base

– Base fissa a quattro gambe in tubolare d'acciaio cromato con piedini regolabili.
– Base a disco in acciaio rivestito in acciaio inox, girevole o girevole con ritorno automatico in posizione.
– Base a cinque razze in alluminio lucidato, con ruote o piedini fissi. Le ruote piroettanti autofrenanti sono in nylon con battistrada in poliuretano. I piedini fissi sono in nylon.

Meccanismi

– Regolazione in altezza della seduta con pompa a gas.
– Oscillazione della poltrona con movimento sincron multiblock, con regolazione dell'oscillazione e sistema di sicurezza anti-ritorno.

FR

Matériaux

– Assise en bois de bouleau multiplis et dossier en tubes d'acier avec rembourrage en mousse de polyuréthane autoextinguible moulée à froid.

Types de dossier

– Haut avec appuie-tête.
– Bas.

Accoudoirs

– Fermés ou intégrés au dossier, avec finition supérieure en hêtre verni ou revêtue.
– Ouverts en polyuréthane intégral avec insert en acier ou revêtus. **(1)**

Types de piètement

– Piètement à quatre jambes en tubes d'acier chromé avec pieds réglables.
– Piètement à disque en acier revêtu inox, pivotant ou pivotant avec repositionnement automatique.
– Piètement à cinq branches en aluminium poli, avec roulettes ou pieds fixes. Les roulettes pivotantes autofrenantes sont en nylon avec chape en polyuréthane. Les pieds fixes sont en nylon.

Mécanismes

– Réglage en hauteur du siège avec vérin à gaz.
– Oscillation du fauteuil avec des mouvements mécanisme synchrone multiblock avec réglage de l'oscillation et système de sécurité anti-retour.

DE

Materialien

– Sitz aus Birkensperrholz und Rückenlehne aus Stahlrohr mit Polsterung aus selbstverlöschendem, kaltgeschäumtem Polyurethan.

Typen von Rückenlehnen

– Hoch mit Kopfteil.
– Niedrig.

Armlehnen

– Geschlossen und in die Rückenlehne integriert, mit hochwertigem Finish in Buche lackiert oder beschichtet.
– Offen aus reißfestem Integral-Polyurethan mit Stahleinlage oder beschichtet. **(1)**

Grundmodelle

– Standfuß mit vier Beinen aus verchromtem Stahlrohr mit einstellbaren Standfüßen.
– Mit Edelstahl beschichteter Stahl-Tellerfuß, drehbar oder drehbar mit automatischer Rückstellfunktion.
– Fünfarmiges Fußkreuz aus poliertem Aluminium mit Rollen oder festen Standfüßen. Die selbstbremsenden Schwenkräder bestehen aus Nylon mit Polyurethan-Lauffläche. Die festen Standfüße bestehen aus Nylon.

Funktionen

– Sitzhöhenverstellung mit Gasdruckfeder.
– Drehbarer Sitz mit synchronen Multiblock-Bewegungen mit Schwingungsverstellung und Sicherheits-Rückschwingsperrsystem.

ES

Materiales

– Asiento en multicapa de abedul y respaldo en tubular de acero con acolchado de poliuretano autoextinguible espumado en frío.

Tipos de respaldo

– Alto con reposacabezas.
– Bajo.

Brazos

– Cerrados e integrados en el respaldo, con acabado superior en madera de haya pintada o forrados.
– Abiertos, de poliuretano de piel integral con inserción de acero o tapizados. **(1)**

Tipos de base

– Base de cuatro patas, en tubular de acero cromado con pies regulables.
– Base de disco de acero revestido de acero inoxidable, giratoria o giratoria con retorno automático.
– Base de cinco radios de aluminio pulido, con ruedas o pies fijos. Las ruedas pivotantes autofrenantes son de nailon con banda de rodadura en poliuretano. Los pies fijos son de nailon.

Mecanismos

– Altura del asiento regulable con pistón a gas.
– Oscilación de la silla con movimiento sincron multiblock, con regulación de la oscilación y sistema de seguridad antirretorno.



EN – Warranty IT – Garanzia
FR – Garantie DE – Garantie
ES – Garantía

Link Family

Link XPlus



BaccolinDesign

Link Plus



Link



Link Family

mod. 5715

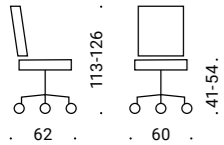

mod. 5713

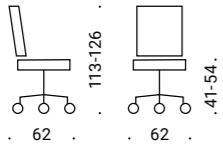

mod. 5718

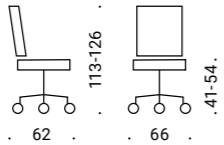

mod. 5735

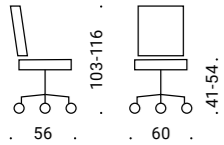

mod. 5733

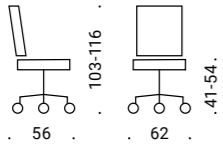

mod. 5738

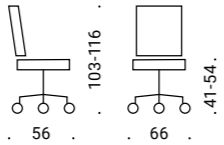

mod. 5731

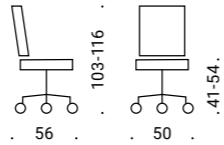

mod. 5735S

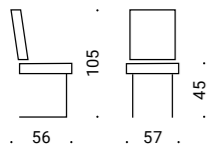

Models



Link XPlus



mod. 5615

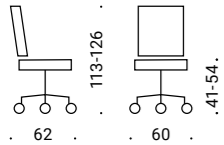

mod. 5613

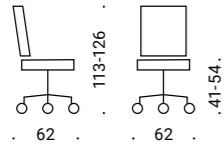
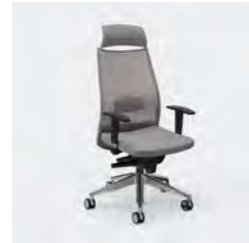

mod. 5618

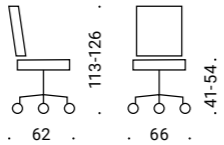
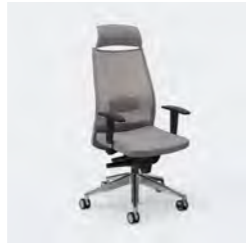

mod. 5635

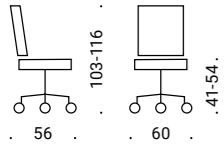

mod. 5633

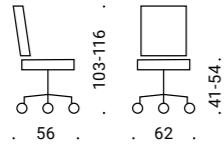
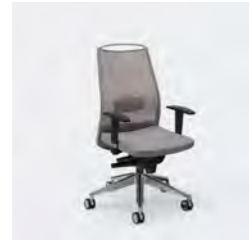

mod. 5638

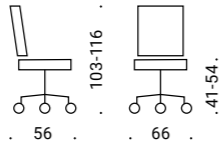
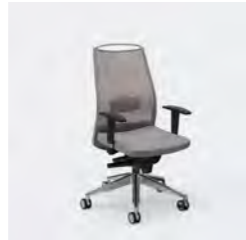

mod. 5631

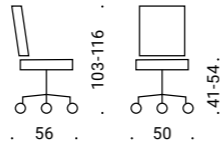

mod. 5635S

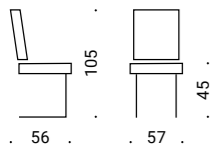

Models

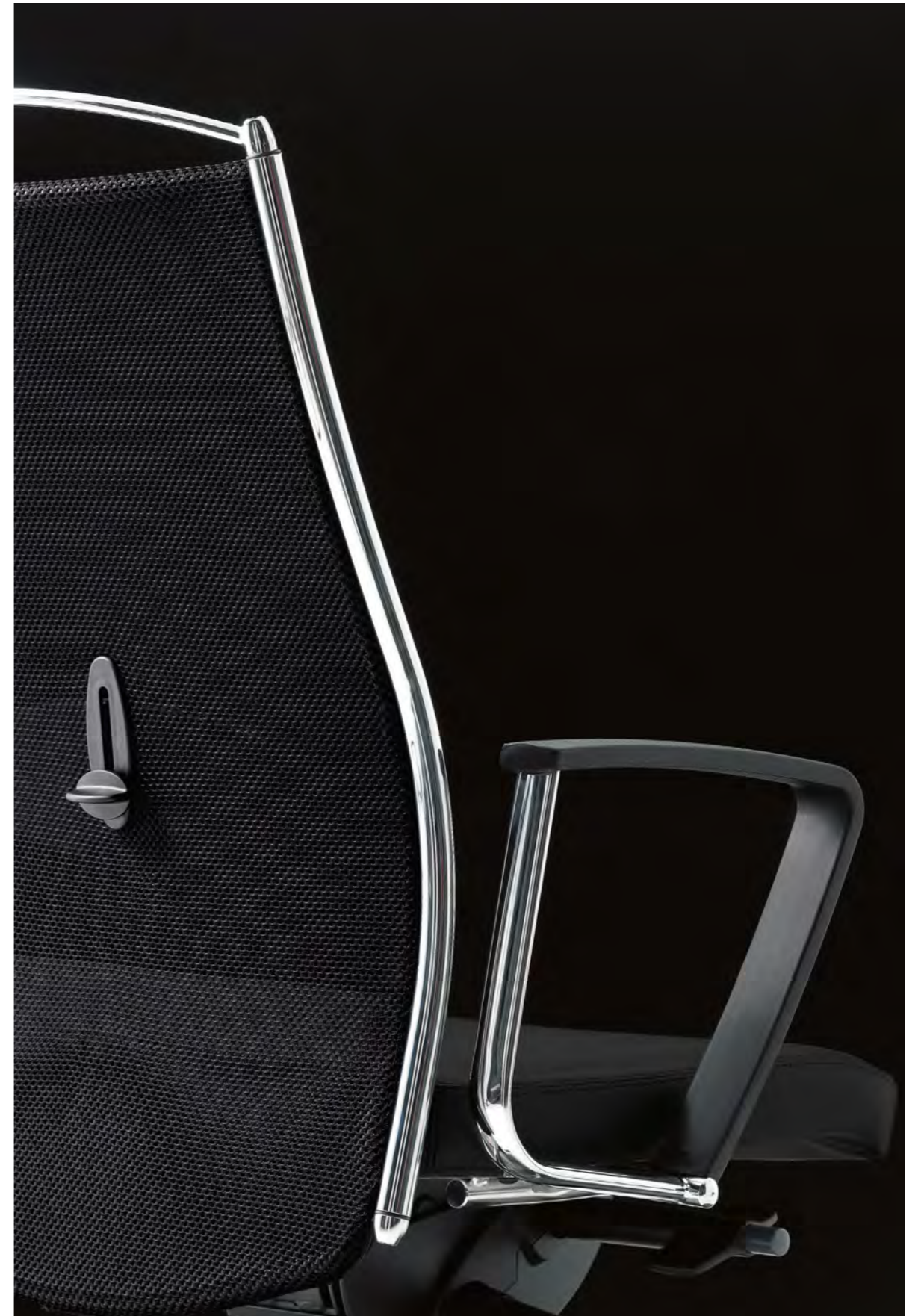

Link Plus





mod. 5515

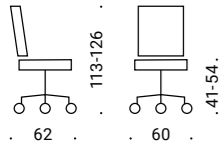
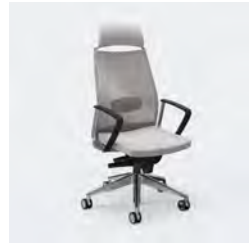

mod. 5513

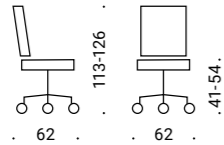
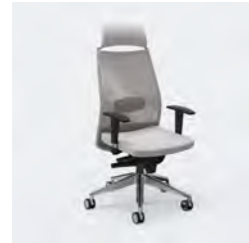

mod. 5518

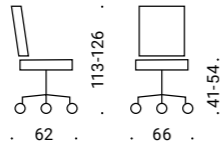

mod. 5535

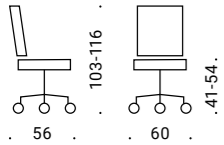
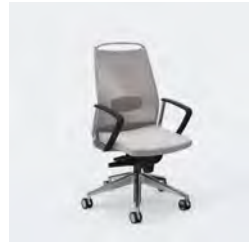

mod. 5533

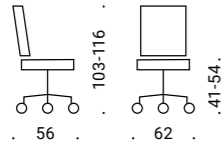
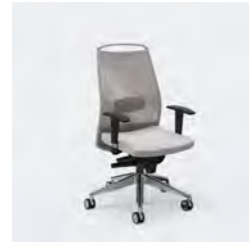

mod. 5538

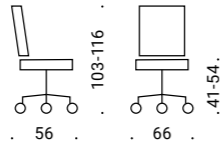
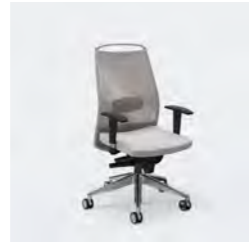

mod. 5531

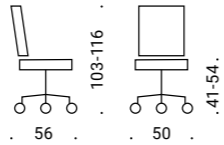

mod. 5535S

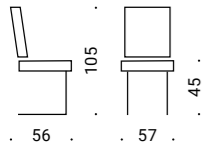

Models



Link

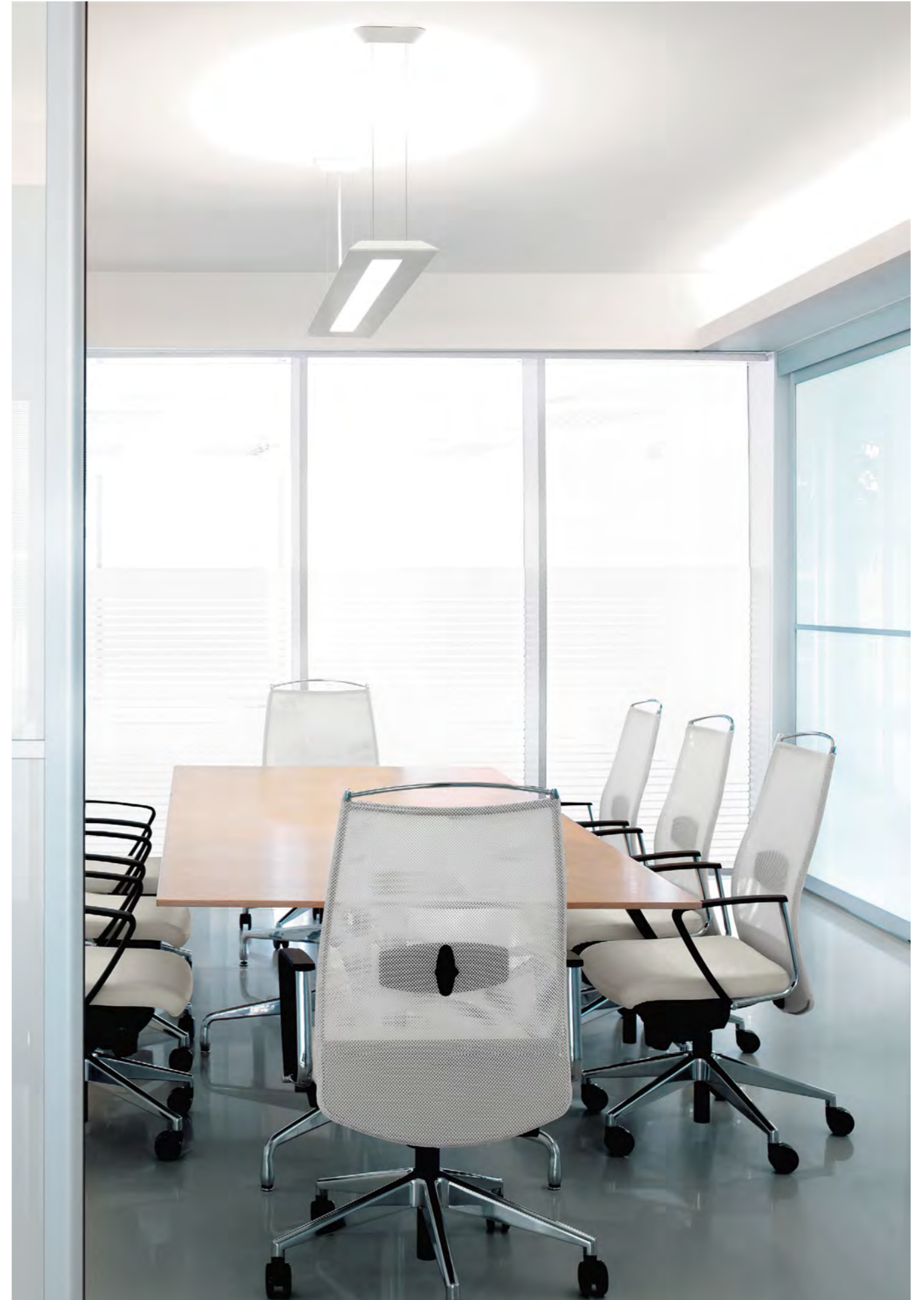

EN

Materials*Link and Link Plus*

– Seat in beech plywood with padding in self-extinguishing shape-retaining synthetic foam.

Backrest with tubular steel frame and elastic fire-retardant mesh.

Link XPlus

– Seat in beech plywood with padding in self-extinguishing shape-retaining synthetic foam. Backrest with tubular steel frame and elastic fire-retardant mesh, padding in self-extinguishing shape-retaining synthetic foam.

Types of backrest*All models*

- High with headrest.
- Medium.

Base types*All models*

- Sled base in asform tubular steel, powder coated or chromed.
- Five-spoke base in nylon or polished aluminium, with castors or fixed feet.
- Self-braking swivel castors made of nylon with polyurethane tread. Fixed feet in nylon.

Mechanisms*All models*

- Seat height adjustment with gas cylinder.
- Lumbar support height adjustment.
- Seat tilt with Synchron multiblock mechanism, Synchron multiblock with adjustable seat depth, Synchron multiblock with adjustable seat depth and forward tilt, all with multi-position locking, tilt adjustment, and anti-return safety system.

Optional accessories*All models*

- Fixed armrests in black integral skin polyurethane.
- Fixed armrests with chromed steel frame and upper surface finish in black integral skin polyurethane.
- Fixed armrests with chromed steel frame and upholstery.
- Adjustable 2D armrests with chromed steel frame and upper surface finish in polypropylene.
- Adjustable 2D armrests with chromed steel frame and surface finish.
- Polyurethane adjustable armrests in the 4D version. *Always with “soft touch” elastomer upholstery. (1-4)*
- Headrest in upholstered integral skin polyurethane with chromed steel frame.
- Seat cushion with integrated micro-springs. **(5)**

IT

Materiali*Link e Link Plus*

– Sedile in legno multistrato di faggio con imbottitura in resine espanse indeformabili autoestinguenti.

Schienale con struttura in tubolare d'acciaio e rete elasticizzata ignifuga.

Link XPlus

– Sedile in legno multistrato di faggio con imbottitura in resine espanse indeformabili autoestinguenti.

Schienale con struttura in tubolare d'acciaio e rete elasticizzata ignifuga, imbottitura in resine espanse indeformabili autoestinguenti.

Tipologie di schienale*Tutti i modelli*

- Alto con poggiatesta.
- Medio.

Tipologie di base*Tutti i modelli*

- Base a slitta in tubolare d'acciaio asform verniciato a polvere o cromato.
- Base a cinque razze in nylon o in alluminio lucidato, con ruote o piedini fissi.
- Le ruote piroettanti autofrenanti sono in nylon con battistrada in poliuretano. I piedini fissi sono in nylon.

Meccanismi*Tutti i modelli*

- Regolazione in altezza della seduta con pompa a gas.
- Regolazione in altezza del supporto lombare.
- Oscillazione della poltrona con movimenti sincron multiblock, sincron multiblock con regolazione della profondità del sedile, sincron multiblock con regolazione in profondità e dell'assetto in negativo del sedile, tutti con bloccaggio in più posizioni, regolazione dell'oscillazione e sistema di sicurezza anti-ritorno.

Accessori opzionali*Tutti i modelli*

- Braccioli fissi in poliuretano integrale autopellante nero.
- Braccioli fissi con struttura in acciaio cromato e finitura superiore in poliuretano integrale autopellante nero.
- Braccioli fissi con struttura in acciaio cromato e rivestimento.
- Braccioli regolabili con struttura in acciaio cromato e finitura superiore in polipropilene.
- Braccioli regolabili con struttura in acciaio cromato e rivestimento.
- Braccioli regolabili in poliuretano nella versione 4D. *Sempre con copertura in elastomero “soft touch”. (1-4)*
- Poggiatesta in poliuretano autopellante rivestito con struttura in acciaio cromato.
- Cuscino sedile con micromolle integrate. **(5)**

FR

Matériaux*Link et Link Plus*

– Assise en bois de hêtre multiplis avec rembourrage en résines expansées indéformables autoextinguibles.

Dossier avec structure en tubes d'acier et résille élastique ignifuge.

Link XPlus

– Assise en bois de hêtre multiplis avec rembourrage en résines expansées indéformables autoextinguibles.

Dossier avec structure en tubes d'acier et résille élastique ignifuge, rembourrage en résines expansées indéformables autoextinguibles.

Types de dossier*Tous les modèles*

- Haut avec appuie-tête.
- Moyen.

Types de piètement*Tous les modèles*

- Piètement luge en tubes d'acier « asform » revêtu par poudre ou chromé.
- Piètement à cinq branches en nylon ou en aluminium poli, avec roulettes ou pieds fixes. Les roulettes pivotantes autofreinantes sont en nylon avec chape en polyuréthane. Les pieds fixes sont en nylon.

Mécanismes*Tous les modèles*

- Réglage en hauteur du siège avec vérin à gaz.
- Réglage en hauteur du soutien lombaire.
- Oscillation du fauteuil avec des mouvements mécanisme synchrone multiblock, mécanisme synchrone multiblock avec réglage de la profondeur de l'assise, mécanisme synchrone multiblock avec réglage de la profondeur et mécanisme d'assise négative, tous avec blocage possible dans plusieurs positions, réglage de l'oscillation et système de sécurité anti-retour.

Accessoires en option*Tous les modèles*

- Accoudoirs fixes en polyuréthane intégral noir.
- Accoudoirs fixes avec structure en acier chromé et finition supérieure en polyuréthane intégral noir.
- Accoudoirs fixes avec structure en acier chromé et revêtement.
- Accoudoirs réglables 2D avec structure en acier chromé et finition supérieure en polypropylène.
- Accoudoirs réglables 2D avec structure en acier chromé et revêtement.
- Accoudoirs réglables en polyuréthane dans la version 4D. *Toujours avec manchette d'appui confort en élastomère « soft touch ». (1-4)*
- Appuie-tête en polyuréthane intégral revêtu d'une structure en acier chromé.
- Coussin assise avec micro-ressorts intégrés. **(5)**

DE

Materialien*Link und Link Plus*

– Rückenlehne aus Buchensperrholz mit formstabiler, selbstverlöschender Kunstharzschaumpolsterung.

Rückenlehne mit Stahlrohrkonstruktion und elastischem Netzrücken (feuerfest).

Link XPlus

– Sitz aus Buchensperrholz mit Polsterung aus selbstverlöschendem, formstabilem Kunstharzschaum. Rückenlehne mit Stahlrohrkonstruktion und elastischem Netzrücken (feuerfest), Polsterung aus selbstverlöschendem, nicht formstabilem Kunstharzschaum.

Typen von Rückenlehnen*Alle Modelle*

- Hoch mit Kopfteil.
- Mittel.

Grundmodelle*Alle Modelle*

- Kufengestell aus pulverbeschichtetem oder verchromtem Stahlrohr.
- Fünfarmiges Fußkreuz aus Nylon oder poliertem Aluminium mit Rollen oder festen Standfüßen. Die selbstbremsenden Schwenkräder bestehen aus Nylon mit Polyurethan-Lauffläche. Die festen Standfüße bestehen aus Nylon.

Funktionen*Alle Modelle*

- Sitzhöhenverstellung mit Gasdruckfeder.
- Höhenverstellung der Lendenwirbelstütze.
- Drehbarer Sitz mit synchronen Multiblock-Bewegungen, einem synchronen Multiblock mit Sitztiefenverstellung, einem synchronen Multiblock mit Tiefenverstellung und einer negativen Sitzneigung, alle verfügen über eine Verriegelung in mehreren Positionen, eine Schwingungsverstellung und ein Sicherheits-Rückschwingsperrsystem.

Sonderzubehörteile*Alle Modelle*

- Armlehnen: fest aus reißfestem, schwarzem Integral-Polyurethan.
- Armlehnen: fest mit verchromtem Stahlrahmen und einem hochwertigen Finish aus schwarzem, reißfestem Integral-Polyurethan.
- Armlehnen: fest mit verchromtem Stahlrahmen und Bezug.
- Armlehnen: in zwei Ebenen verstellbar mit verchromtem Stahlrahmen und einem



EN – Warranty IT – Garanzia
FR – Garantie DE – Garantie
ES – Garantía

Finish aus Polypropylen.

– Armlehnen: in zwei Ebenen verstellbar mit verchromtem Stahlrahmen und Bezug.

– Armlehnen: in vier Ebenen verstellbar aus Polyurethan. *Immer mit „soft touch“-Gummierung. (1-4)*

– Kopfstütze aus reißfestem Integral-Polyurethan mit verchromtem Stahlgestell.

– Sitzpolster mit integrierten Mikrofedern. **(5)**

ES

Materiales*Link y Link Plus*

– Asiento en multicapa de haya con acolchado de resinas expandidas indeformables y autoextinguibles.

– Respaldo con estructura tubular de acero y malla elástica ignifuga.

Link XPlus

– Asiento en multicapa de haya con acolchado de resinas expandidas indeformables y autoextinguibles. Respaldo con estructura en tubular de acero y malla elástica ignifuga, acolchado de resinas expandidas indeformables y autoextinguibles.

Tipos de respaldo*Todos los modelos*

- Alto con reposacabezas.
- Mediano.

Tipos de base*Todos los modelos*

- Estructura de patín en tubular de acero asform con pintado con polvo o cromado.
- Base de cinco radios de nailon o aluminio pulido con ruedas o pies fijos. Las ruedas pivotantes autofrenantes son de nailon con banda de rodadura en poliuretano. Los pies fijos son de nailon.

Mecanismos*Todos los modelos*

- Altura del asiento regulable con pistón a gas.
- Altura del soporte lumbar regulable.
- Oscilación de la silla con movimientos sincron multiblock, sincron multiblock con ajuste de profundidad del asiento, sincron multiblock con ajuste de profundidad del asiento y con inclinación negativa, todos con bloqueo en diferentes posiciones, regulación de la oscilación y sistema de seguridad antirretorno.

Accesorios opcionales*Todos los modelos*

- Brazos fijos de poliuretano de piel integral negro.
- Brazos fijos con estructura de acero cromado y acabado superior de poliuretano de piel integral negro.
- Brazos fijos con estructura de acero cromado y tapizado.
- Brazos regulables en 2D con estructura de acero cromado y acabado superior de polipropileno.
- Brazos regulables en 2D con estructura de acero cromado y tapizado.

– Brazos regulables de poliuretano en versión 4D. *Siempre con cubierta de elastómero «soft touch». (1-4)*

– Reposacabezas de poliuretano de piel integral revestido con estructura de acero cromado.

– Cojín del asiento con micromuelles integrados. **(5)**



Dotway Family

Dotway Net



Gorgi Design

Dotway Padded



Dotway Family

mod. 6#16



mod. 6#18

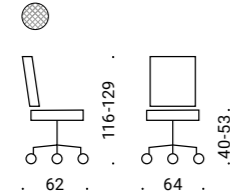
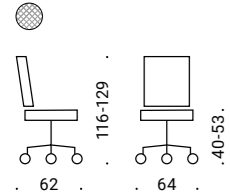
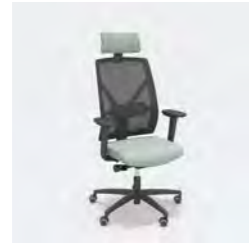

mod. 6#36

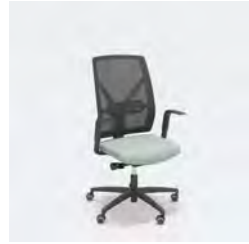

mod. 6#38

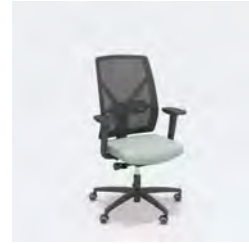

mod. 6#31

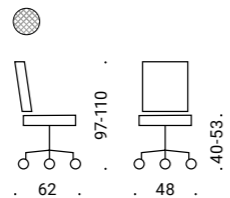
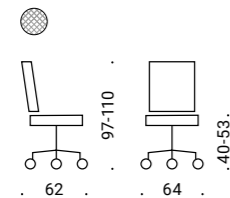
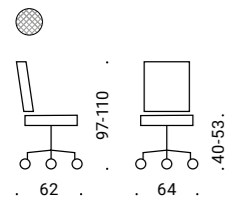

EN – # Plastics IT – # Plastiche FR – # Plastiques DE – # Kunststoffe ES – # Plásticos

2 White 1 Black

EN – Backrest IT – Schienale FR – Dossier DE – Rückenlehne ES – Respaldo

 EN – Mesh
 IT – Rete
 FR – Résille
 DE – Netzgewebe
 ES – Malla

Models



Dotway Net







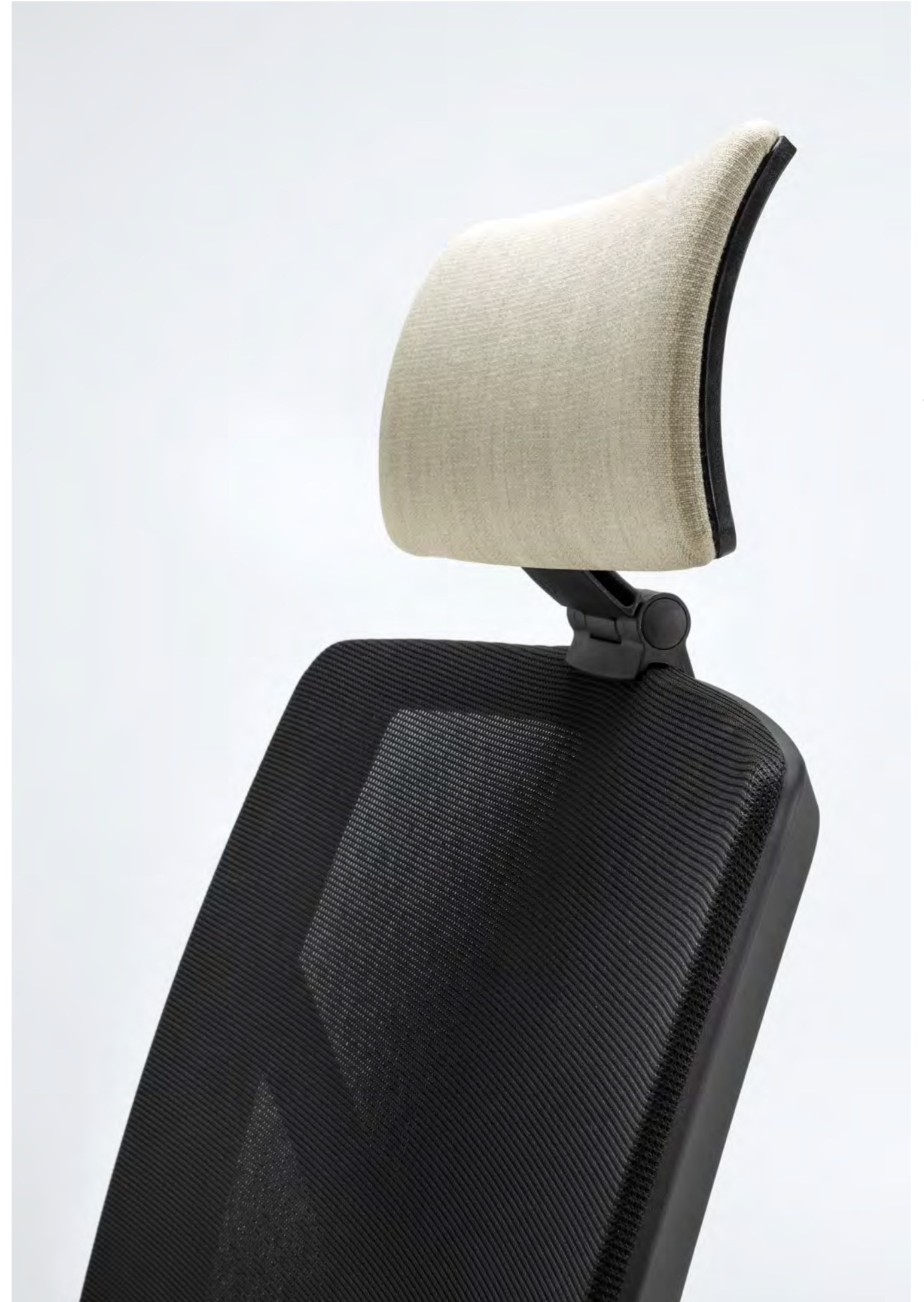

mod. 6#E6



mod. 6#E8

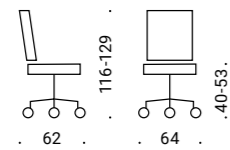
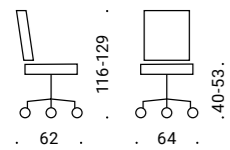
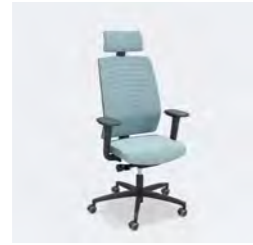

mod. 6#26



mod. 6#28

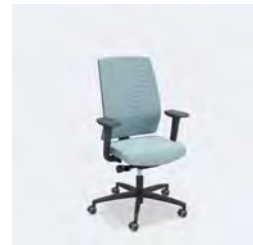

mod. 6#21

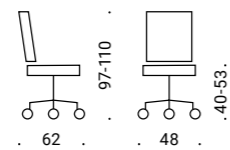
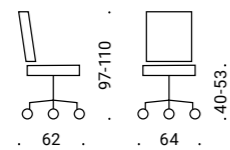
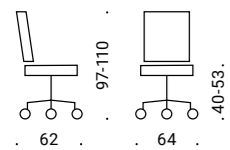
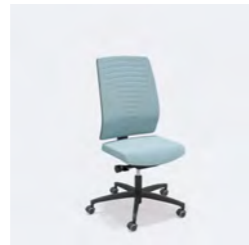

EN - # Plastics IT - # Plastiche FR - # Plastiques DE - # Kunststoffe ES - # Plásticos



White



Black

EN - Backrest IT - Schienale FR - Dossier DE - Rückenlehne ES - Respaldo



EN - Upholstered

IT - Tapezzato

FR - Tapissée

DE - Stoffbezogen

ES - Tapizada

Models

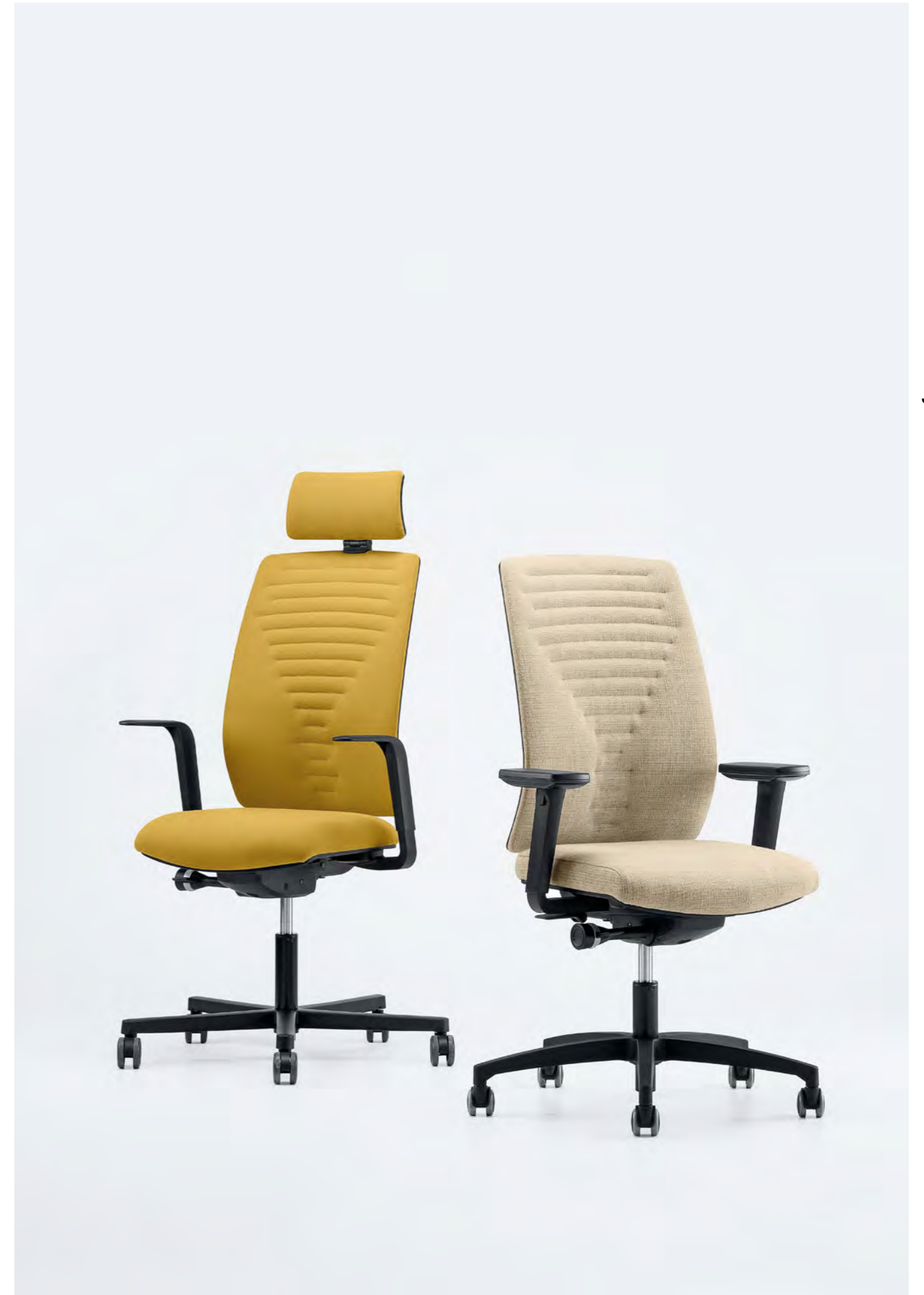

Dotway Padded



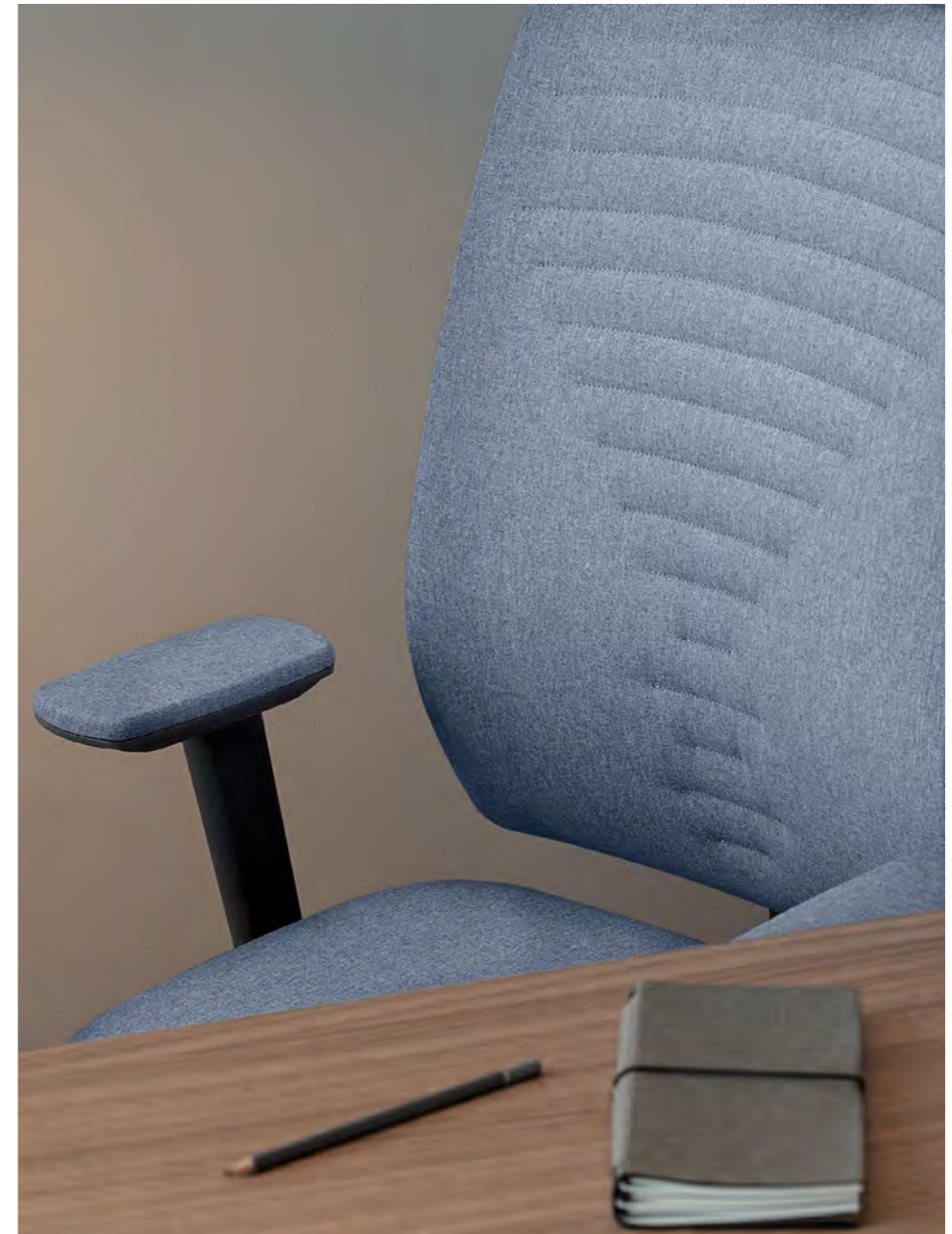

EN

Materials

- Polypropylene shell and seat with padding in self-extinguishing non-deformable expanded resins.
- Backrest in white or black polyamide with fire retardant net.
- Backrest in upholstered white or black polyamide, padded with non-deformable expanded resins and covered in fabric with contrast stitching.
- Lumbar support adjustable in height or depth.

Base types

- Five-spoke base in polyamide, steel and polypropylene, or polished aluminium, with castors or fixed feet. Self-braking swivel castors made of nylon with polyurethane tread. Fixed feet in nylon.

Mechanisms

- Seat height adjustment with gas cylinder.
- Height (1) or depth (2) adjustment of lumbar support.
- Backrest height adjustment. (3)
- Seat tilt with Synchron multiblock mechanism, Synchron multiblock with adjustable seat depth, Synchron multiblock with adjustable seat depth and forward tilt, all with multi-position locking, tilt adjustment, and anti-return safety system.

Optional accessories

- Height-adjustable 1D armrests in black or white polyamide. (4)
- Adjustable polyamide armrests, white or black in the 4D version. (5-8) With black “soft touch” elastomer cover or upholstered.
- Headrest in white or black ABS and polyamide with padding in non-deformable self-extinguishing expanded resin. (9)
- Seat cushion with Memory Foam. (10)

IT

Materiali

- Sottosedile e sedile in polipropilene con imbottitura in resine espanso indeformabili autoestinguenti.
- Schienale in poliammide bianco o nero con rete ignifuga
- Schienale in poliammide bianco o nero tappezzato, imbottito in resine espanso indeformabili e rivestito in tessuto con cuciture a contrasto.
- Supporto lombare regolabile in altezza o profondità.

Tipologie di base

- Base a cinque razze in poliammide, in acciaio e polipropilene o in alluminio lucidato. Le ruote piroettanti autofrenanti sono in nylon con battistrada in poliuretano. I piedini fissi sono in nylon.

Meccanismi

- Regolazione in altezza della seduta con pompa a gas.
- Regolazione in altezza (1) o profondità (2) del supporto lombare.
- Regolazione in altezza schienale. (3)
- Oscillazione della poltrona con movimenti sincron multiblock, sincron multiblock con regolazione della profondità del sedile, sincron multiblock con regolazione in profondità e dell'assetto in negativo del sedile, tutti con bloccaggio in più posizioni, regolazione dell'oscillazione e sistema di sicurezza anti-ritorno.

Accessori opzionali

- Braccioli 1D regolabili in altezza in poliammide bianco o nero. (4)
- Braccioli regolabili in poliammide bianco o nero nella versione 4D. (5-8) Copertura in elastomero “soft touch” nero o tappezzata.
- Poggiatesta in ABS e poliammide bianco o nero con imbottitura in resine espanso indeformabili autoestinguenti. (9)
- Cuscino sedile con Memory Foam. (10)

FR

Matériaux

- Partie sous l'assise et assise en polypropylène avec rembourrage en résines expansées indéformables autoextinguibles.
- Dossier en polyamide blanc ou noir avec maille ignifuge
- Dossier en polyamide blanc ou noir tapissé, rembourré en résines expansées indéformables et revêtu en tissu avec coutures contrastantes.
- Support lombaire réglable en hauteur et en profondeur.

Types de piètement

- Piètement à cinq branches en polyamide, en acier et propylène ou en aluminium poli avec roulettes ou pieds fixes. Les roulettes pivotantes autofreinantes sont en nylon avec chape en polyuréthane. Les pieds fixes sont en nylon.

Mécanismes

- Réglage en hauteur du siège avec vérin à gaz.
- Support lombaire réglable en hauteur (1) et en profondeur (2).
- Dossier réglable en hauteur. (3)
- Oscillation du fauteuil avec des mouvements mécanisme synchrone multiblock, mécanisme synchrone multiblock avec réglage de la profondeur de l'assise, mécanisme synchrone multiblock avec réglage de la profondeur et mécanisme d'assise négative, tous avec blocage possible dans plusieurs positions, réglage de l'oscillation et système de sécurité anti-retour.

Accessoires en option

- Accoudoirs 1D réglables en hauteur en polyamide blanc ou noir. (4)
- Accoudoirs réglables en polyamide blanc ou noir dans la version 4D. (5-8) Revêtement en élastomère « soft touch » noir ou tapissé.
- Appui-tête en ABS et polyamide blanc ou noir avec rembourrage en résines expansées indéformables autoextinguibles. (9)
- Coussin siège avec mousse à mémoire de forme. (10)

DE

Materialien

- Untersitz aus Polypropylen mit Polsterung aus nicht verformbarem selbstverlöschendem Harzschaum.
- Rückenlehne aus weißem oder schwarzem Polyamid mit feuerfestem Netzgewebe.
- Rückenlehne aus weißem oder schwarzem bezogenem Polyamid mit Polsterung aus unverformbarem Harzschaum und mit Gewebe mit Kontrastnähten bezogen.
- In Höhe und Tiefe verstellbare Lendenstütze.

Grundmodelle

- Fünfstrahliger Fuß aus Polyamid, Stahl und Polypropylen oder aus poliertem Aluminium mit Rollen oder festen Standfüßen. Die selbstbremsenden Schwenkräder bestehen aus Nylon mit Polyurethan-Lauffläche. Die festen Standfüße bestehen aus Nylon.

Funktionen

- Sitzhöhenverstellung mit Gasdruckfeder.
- Höhen- und Tiefenverstellung der Lendenstütze. (1-2)
- Höheneinstellung der Rückenlehne. (3)
- Drehbarer Sitz mit synchronen Multiblock-Bewegungen, einem synchronen Multiblock mit Sitztiefenverstellung, einem synchronen Multiblock mit Tiefenverstellung und einer negativen Sitzneigung, alle verfügen über eine Verriegelung in mehreren Positionen, eine Schwingungsverstellung und ein Sicherheits-Rückschwingsperrsystem.

Sonderzubehörteile

- Höhenverstellbare 1D-Armlehnen aus weißem oder schwarzem Polyamid. (4)
- Verstellbare Armlehnen aus weißem oder schwarzem Polyamid in der Ausführung 4D. (5-8) Bezug aus schwarzem „Soft-Touch“-Elastomer oder Polsterung.
- Kopfstütze aus ABS und weißem oder schwarzem Polyamid mit Polsterung aus nicht verformbarem selbstverlöschendem Harzschaum. (9)
- Sitzkissen mit Memory-Schaumstoff. (10)

ES

Materiales

- Placa bajo el asiento y asiento en polipropileno con acolchado de resinas expandidas indeformables autoextinguibles.
- Respaldo en poliamida blanco o negro con malla ignífuga
- Respaldo en poliamida blanco o negro tapizado, acolchado en resinas expandidas indeformables y forrado en tejido con costuras en contraste.
- Soporte lumbar con ajuste en altura o profundidad.

Tipos de base

- Base de cinco radios de poliamida, acero y polipropileno o en aluminio pulido con ruedas o pies fijos. Las ruedas pivotantes autofrenantes son de nailon con banda de rodadura en poliuretano. Los pies fijos son de nailon.

Mecanismos

- Altura del asiento regulable con pistón a gas.
- Soporte lumbar regulable en altura (1) o profundidad (2).
- Respaldo con ajuste de altura regulable. (3)
- Oscilación de la silla con movimientos sincron multiblock, sincron multiblock con ajuste de profundidad del asiento, sincron multiblock con ajuste de profundidad del asiento y con inclinación negativa, todos con bloqueo en diferentes posiciones, regulación de la oscilación y sistema de seguridad antirretorno.

Accesorios opcionales

- Brazos 1D de altura regulable en poliamida blanca o negra. (4)
- Brazos regulables de poliamida blanca o negra en la versión 4D. (5-8) Cubierta en elastómero “soft touch” negro o tapizada.
- Reposacabezas en ABS y poliamida blanco o negro con acolchado en resinas expandidas indeformables autoextinguibles. (9)
- Cojín del asiento con Memory Foam. (10)

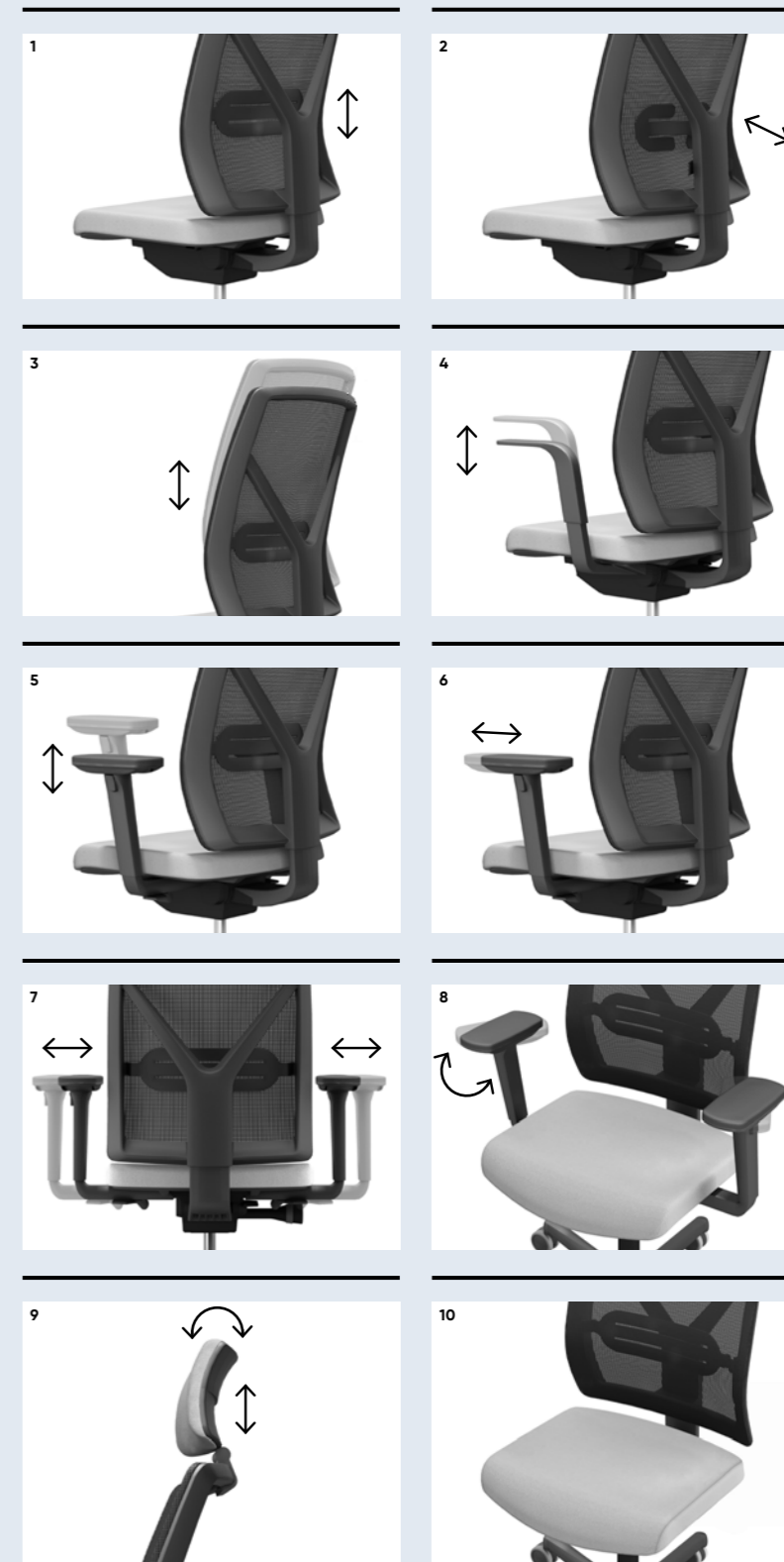

EN – Warranty IT – Garanzia
FR – Garantie DE – Garantie
ES – Garantía

Zero7 Family

Zero7 Elegant



BaccolinDesign

Zero7



Zero7 Family

mod. 7BE6

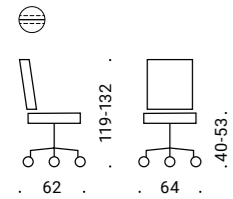

mod. 7BE8

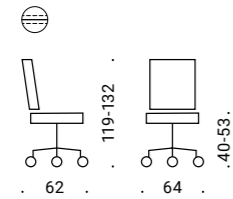
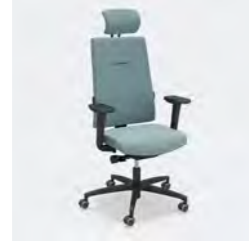

mod. 7B16

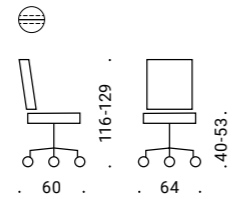
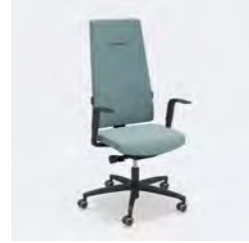

mod. 7B18

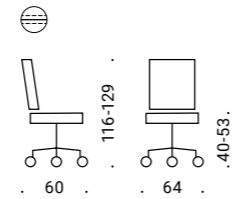
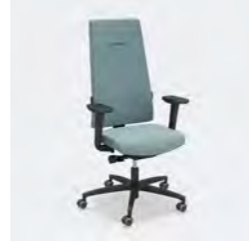

mod. 7B26

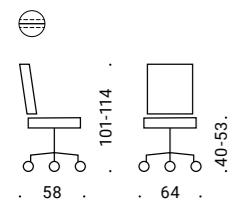

mod. 7B28

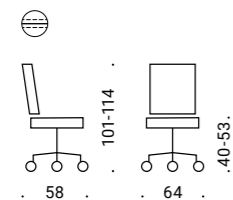
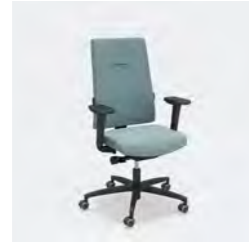

mod. 7B21

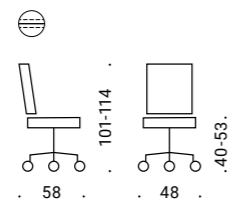
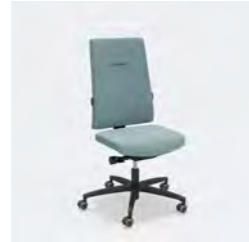

EN – Plastics IT – Plastiche FR – Plastiques DE – Kunststoffe ES – Plásticos

● Black

EN – Backrest IT – Schienale FR – Dossier DE – Rückenlehne ES – Respaldo

⊕ EN – Fully upholstered
IT – Tutto tappezzato
FR – Entièrement tapissée
DE – Alle Polster
ES – Completamente tapizada

Models



Zero7 Elegant



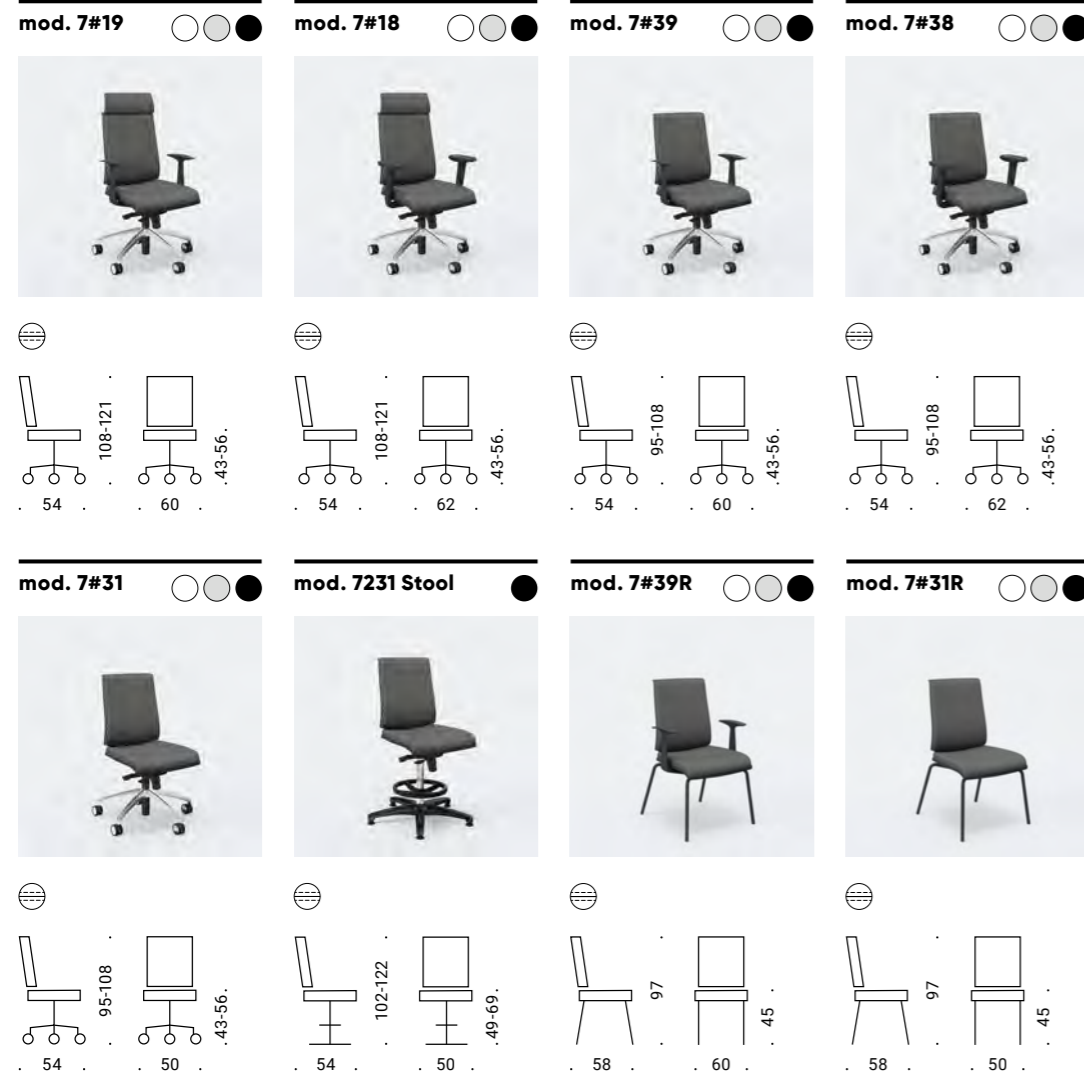

Models



Zero7

EN – # Plastics IT – # Plastiche FR – # Plastiques DE – # Kunststoffe ES – # Plásticos

4 White 3 Grey 2 Black

EN – Backrest IT – Schienale FR – Dossier DE – Rückenlehne ES – Respaldo

EN – Upholstered
 IT – Tapezzato
 FR – Tapissée
 DE – Stoffbezogen
 ES – Tapizada





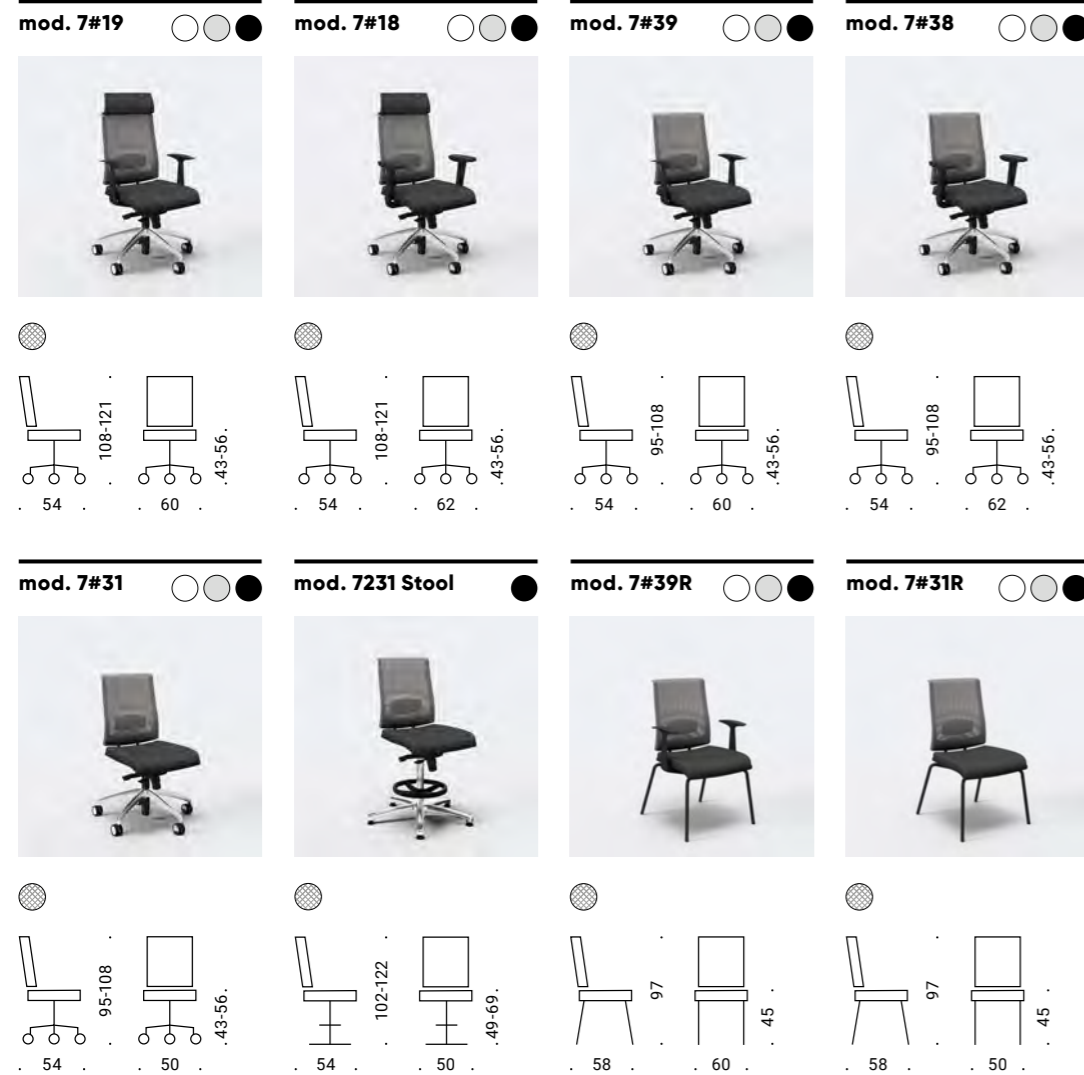

EN – # Plastics IT – # Plastiche FR – # Plastiques DE – # Kunststoffe ES – # Plásticos

④ White ③ Grey ② Black

EN – Backrest IT – Schienale FR – Dossier DE – Rückenlehne ES – Respaldo

● EN – Mesh
IT – Rete
FR – Résille
DE – Netzgewebe
ES – Malla

Models



Zero7 net



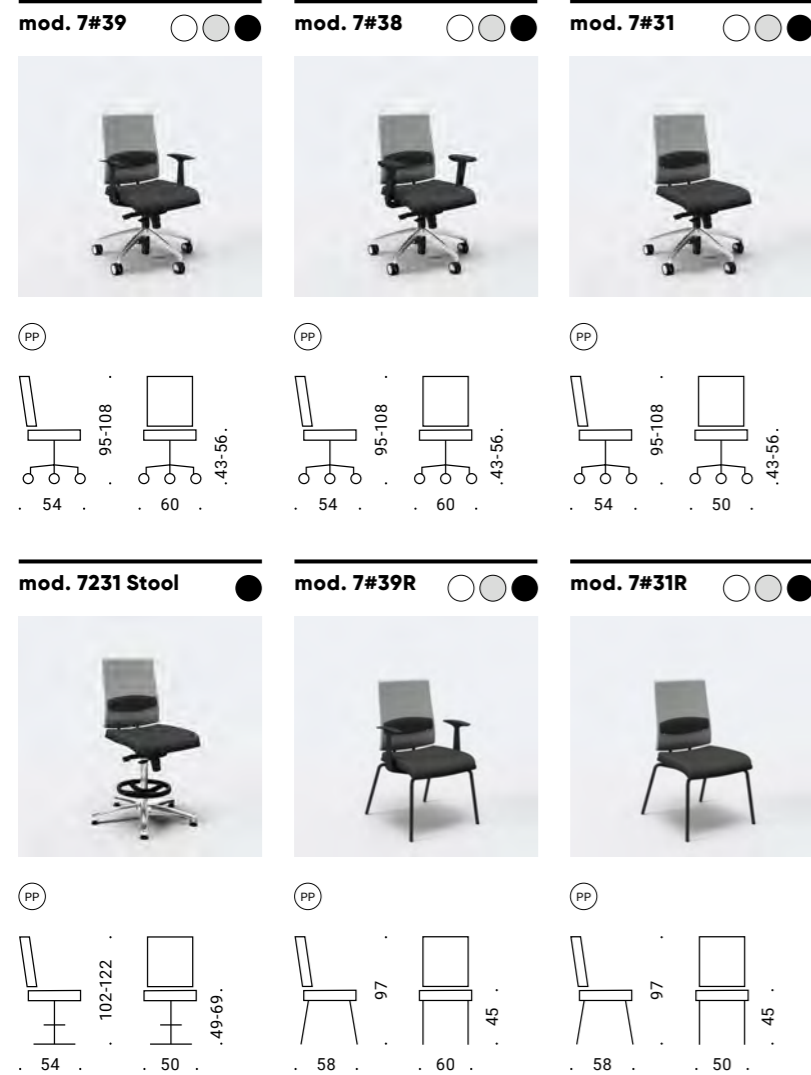

EN — # Plastics IT — # Plastiche FR — # Plastiques DE — # Kunststoffe ES — # Plásticos

4 White 3 Grey 2 Black

EN — Backrest IT — Schienale FR — Dossier DE — Rückenlehne ES — Respaldo

PP EN — Polypropylene
IT — Polipropilene
FR — Polypropylène
DE — Polypropylen
ES — Polipropileno

Models



Zero7 polypropylene



Zero7 polypropylene

Office
<div> <div></div> <div></div> </div>
<div>EN</div>
<div>Materials</div>
<div><i>Zero7 Elegant</i></div>
<div><div><div>– Polypropylene seat and shell with padding in self-extinguishing non-deformable expanded resins.</div></div></div>
<div><div><div>Height adjustable backrest in completely upholstered beech plywood, with contoured, flexible, self-extinguishing polyurethane padding.</div></div></div>
<div><div><div>Lumbar support in polypropylene.</div></div></div>

<div><i>Zero7</i></div>
<div><div><div>– Seat in beech plywood; shell in dent- and scratch-resistant black polypropylene, padded with contoured, self-extinguishing, flexible polyurethane.</div></div></div>
<div><div><div>– Exposed backrest in black, grey or white polypropylene.</div></div></div>
<div><div><div>Lumbar support in ABS covered with soft black polyurethane.</div></div></div>
<div><div><div>– Backrest in black, grey or white polypropylene with panel padded in contoured, self-extinguishing, flexible polyurethane.</div></div></div>
<div><div><div>Lumbar support in polypropylene.</div></div></div>
<div><div><div>– Backrest consisting of black nylon frame covered with polyester mesh.</div></div></div>
<div><div><div>Lumbar support in blown black polyethylene.</div></div></div>

<div>Base types</div>
<div><i>Zero7 Elegant</i></div>
<div><div><div>– Five-spoke base in black polyamide, black steel and polypropylene, or polished aluminium, with castors or fixed feet.</div></div></div>
<div><div><div>Self-braking swivel castors made of nylon with polyurethane tread.</div></div></div>
<div><div><div>Fixed feet in nylon.</div></div></div>

<div><i>Zero7</i></div>
<div><div><div>– Five-spoke base with wheels or feet.</div></div></div>
<div><div><div>The base is in black, white or grey fibreglass-reinforced nylon, or in polished aluminium.</div></div></div>
<div><div><div>Self-braking swivel castors made of nylon with polyurethane tread.</div></div></div>
<div><div><div>Fixed feet in nylon.</div></div></div>
<div><div><div>– Fixed base with four legs in tubular steel varnished black or chrome.</div></div></div>

<div>Mechanisms</div>
<div><i>Zero7 Elegant</i></div>
<div><div><div>– Backrest height adjustment.</div></div></div>

<div><i>All models, exept for fixed-base versions</i></div>
<div><div><div>– Height adjustment of the seat via a gas pump.</div></div></div>
<div><div><div>– Height adjustment of the lumbar support.</div></div></div>
<div><div><div>– Models with a swivelling seat can be equipped with multiblock synchron movement, multiblock synchron movement with sliding seat, multiblock synchron movement with sliding seat and forward seat-tilt adjustment, all with multi-position locking, oscillation adjustment and anti-shock safety system.</div></div></div>

<div>Optional accessories</div>
<div><i>Zero7 Elegant</i></div>
<div><div><div>– Height-adjustable 1D armrests in black or white polyamide.</div></div></div>
<div><div><div>– Adjustable polyamide armrests, white or black in the 4D version.</div></div></div>
<div><div><div>With black “soft touch” elastomer cover or upholstered.</div></div></div>
<div><div><div>– Polypropylene headrest with adjustable height and tilt, upholstered and padded with self-extinguishing flexible polyurethane.</div></div></div>
<div><div><div>– Seat cushion with Memory Foam.</div></div></div>

<div><i>Zero7</i></div>
<div><div><div>– Polypropylene headrest upholstered and padded with self-extinguishing flexible polyurethane.</div></div></div>
<div><div><div>– Fixed armrests in black, grey or white polypropylene, or adjustable 4D armrests with a black or grey nylon structure and comfortable "soft touch" elastomer cover.</div></div></div>
<div><div><div>– Seat cushion with stitching.</div></div></div>
<div><div><div>– Seat cushion with integrated micro-springs (only with seams).</div></div></div>
<div><div><div>– Height-adjustable footrest in reinforced nylon.</div></div></div>

<div>IT</div>
<div>Materiali</div>
<div><i>Zero7 Elegant</i></div>
<div><div><div>– Sottosedile e sedile in polipropilene con imbottitura in resine espanse indeformabili autoestinguenti.</div></div></div>
<div><div><div>Schienale regolabile in altezza in legno multistrato di faggio completamente rivestito, con imbottitura in poliuretano flessibile indeformabile e autoestinguente.</div></div></div>
<div><div><div>Supporto lombare in polipropilene.</div></div></div>

<div><i>Zero7</i></div>
<div><div><div>– Sedile in legno multistrato di faggio; scocca in polipropilene nero, grigio o bianco, antiurto e antigraffio; imbottitura in poliuretano flessibile indeformabile e autoestinguente.</div></div></div>
<div><div><div>– Schienale in polipropilene a vista nei colori nero, grigio o bianco.</div></div></div>
<div><div><div>Supporto lombare in ABS rivestito in poliuretano morbido nero.</div></div></div>
<div><div><div>– Schienale in polipropilene nei colori nero, grigio o bianco con pannello imbottito in poliuretano flessibile indeformabile e autoestinguente.</div></div></div>
<div><div><div>Supporto lombare in polipropilene.</div></div></div>
<div><div><div>– Schienale realizzato con telaio in nylon nero e rivestito con rete in poliestere.</div></div></div>
<div><div><div>Supporto lombare in polietilene insufflato nero.</div></div></div>

<div>Tipologie di base</div>
<div><i>Zero7 Elegant</i></div>
<div><div><div>– Base a cinque razze in poliammide nero, in acciaio e polipropilene nero o in alluminio lucidato.</div></div></div>
<div><div><div>Le ruote piroettanti autofrenanti sono in nylon con battistrada in poliuretano.</div></div></div>

<div>I piedini fissi sono in nylon.</div>

<div><i>Zero7</i></div>
<div><div><div>– Base a cinque razze è in nylon rinforzato con fibra di vetro di colore nero, grigio o bianco, o in alluminio lucidato.</div></div></div>
<div><div><div>Le ruote piroettanti autofrenanti sono in nylon con battistrada in poliuretano.</div></div></div>
<div>I piedini fissi sono in nylon.</div>

<div>Meccanismi</div>
<div><i>Zero7 Elegant</i></div>
<div><div><div>– Regolazione in altezza schienale.</div></div></div>

<div><i>Tutti i modelli</i></div>
<div><div><div>– Regolazione in altezza della seduta con pompa a gas.</div></div></div>
<div><div><div>– Regolazione in altezza del supporto lombare.</div></div></div>
<div><div><div>(6)</div></div></div>
<div><div><div>– I modelli con seduta girevole possono essere dotati di oscillazione della poltrona con movimenti sincron multiblock, sincron multiblock con regolazione della profondità del sedile, sincron multiblock con regolazione in profondità e dell’assetto in negativo del sedile, tutti con bloccaggio in più posizioni, regolazione dell’oscillazione e sistema di sicurezza anti-ritorno.</div></div></div>

<div>Accessori opzionali</div>
<div><i>Zero7 Elegant</i></div>
<div><div><div>– Braccioli 1D regolabili in altezza in poliammide bianco o nero.</div></div></div>
<div><div><div>– Braccioli regolabili in poliammide bianco o nero nella versione 4D.</div></div></div>
<div><div><div><i>Sempre con copertura in elastomero "soft touch".</i></div></div></div>
<div><div><div>– Poggiatesta in polipropilene regolabile in altezza e inclinazione rivestito e imbottito in poliuretano flessibile autoestinguente.</div></div></div>
<div><div><div>– Cuscino sedile con Memory Foam.</div></div></div>

<div><i>Zero7</i></div>
<div><div><div>– Braccioli fissi in polipropilene nero, grigio o bianco, o regolabili 4D con struttura in nylon nero o grigio e copertina di appoggio comfort in elastomero “soft touch”.</div></div></div>
<div><div><div>– Cuscino sedile con cuciture.</div></div></div>
<div><div><div>– Cuscino sedile con micromolle integrate (solo con cuciture).</div></div></div>
<div><div><div>– Poggiatesta in polipropilene rivestito e imbottito in poliuretano flessibile autoestinguente.</div></div></div>
<div><div><div>– Poggiapiedi regolabile in altezza in nylon rinforzato.</div></div></div>

<div>FR</div>
<div>Matériaux</div>
<div><i>Zero7 Elegant</i></div>
<div><div><div>– Partie sous l'assise et assise en polypropylène avec rembourrage en résines expansées indéformables autoextinguibles.</div></div></div>
<div><div><div>Dossier réglable en hauteur en bois de hêtre multiplis complètement revêtu,</div></div></div>

<div>Zero7 Family</div>

<div>avec rembourrage en polyuréthane flexible indéformable et autoextinguible.</div>
<div>Soutien lombaire en polypropylène.</div>
<div><i>Zero7</i></div>
<div><div><div>– Assise en bois de hêtre multicouche ; structure en polypropylène noir, antichoc et anti-rayures ; rembourrage en polyuréthane flexible indéformable et autoextinguible.</div></div></div>
<div><div><div>– Dossier en polypropylène apparent noir, gris ou blanc.</div></div></div>
<div><div><div>Soutien lombaire en ABS revêtu en polyuréthane souple noir.</div></div></div>
<div><div><div>– Dossier en polypropylène noir, gris ou blanc avec panneau rembourré en polyuréthane flexible indéformable et autoextinguible.</div></div></div>
<div><div><div>Soutien lombaire en polypropylène.</div></div></div>
<div><div><div>– Dossier réalisé avec cadre en nylon noir et revêtu de résille en polyester.</div></div></div>
<div><div><div>Soutien lombaire en polyéthylène soufflé noir.</div></div></div>

<div>Types de piètement</div>
<div><i>Zero7 Elegant</i></div>
<div><div><div>– Piètement à cinq branches en polyamide noir, en acier et propylène noir ou en aluminium poli avec roulettes ou pieds fixes.</div></div></div>
<div><div><div>Les roulettes pivotantes autofreinantes sont en nylon avec chape en polyuréthane.</div></div></div>
<div><div><div>Les pieds fixes sont en nylon.</div></div></div>

<div><i>Zero7</i></div>
<div><div><div>– Piètement à cinq branches avec roulettes ou pieds.</div></div></div>
<div><div><div>Le piètement est en nylon noir, blanc ou gris renforcé de fibres de verre, ou en aluminium poli.</div></div></div>
<div><div><div>Les roulettes pivotantes autofreinantes sont en nylon avec chape en polyuréthane.</div></div></div>
<div><div><div>Les pieds fixes sont en nylon.</div></div></div>
<div><div><div>– Piètement fixe à quatre pieds en tubes d’acier verni noir ou chromé.</div></div></div>

<div>Mécanismes</div>
<div><i>Zero7 Elegant</i></div>
<div><div><div>– Dossier réglable en hauteur.</div></div></div>

<div><i>Tous les modèles, sauf dans les versions avec piètement fixe</i></div>
<div><div><div>– Réglage en hauteur du siège avec vérin à gaz.</div></div></div>
<div><div><div>– Réglage en hauteur du soutien lombaire.</div></div></div>
<div><div><div>(6)</div></div></div>
<div><div><div>– Les modèles avec assise pivotante peuvent être équipés d’un système d’oscillation du fauteuil avec des mouvements mécanisme synchrone multiblock, mécanisme synchrone multiblock avec réglage de la profondeur du assise, mécanisme synchrone multiblock avec réglage de la profondeur et mécanisme d’assise négative, tous avec blocage possible dans plusieurs positions,</div></div></div>
<div><div><div>réglage de l’oscillation et système de sécurité anti-retour.</div></div></div>

<div>Accessoires en option</div>
<div><i>Zero7 Elegant</i></div>
<div><div><div>– Accoudoirs 1D réglables en hauteur en polyamide blanc ou noir.</div></div></div>

<div>–</div>
<div>Accoudoirs réglables en polyamide blanc ou noir dans la version 4D.</div>
<div>Revêtement en élastomère « soft touch » noir ou tapissé.</div>
<div>–</div>
<div>Appuie-tête en polypropylène, hauteur et inclinaison réglables, revêtu et rembourré en polyuréthane flexible autoextinguible.</div>
<div>–</div>
<div>Coussin siège avec mousse à mémoire de forme.</div>

<div><i>Zero7</i></div>
<div><div><div>– Appuie-tête en polypropylène revêtu et rembourré en polyuréthane flexible autoextinguible.</div></div></div>
<div><div><div>– Accoudoirs fixes en polypropylène noir, gris ou blanc, ou réglables 4D avec structure en nylon noir ou gris et manchette d’appui confort en élastomère « soft touch ».</div></div></div>
<div><div><div>– Coussin assise avec coutures.</div></div></div>
<div><div><div>– Coussin assise avec microressorts intégrés (uniquement avec coutures).</div></div></div>
<div><div><div>(5)</div></div></div>
<div><div><div>– Repose-pieds réglable en hauteur en nylon renforcé.</div></div></div>

<div>DE</div>
<div>Materialien</div>
<div><i>Zero7 Elegant</i></div>
<div><div><div>– Untersitz und aus sitzfläche Polypropylen mit Polsterung aus nicht verformbarem selbstverlöschendem Harzschäum.</div></div></div>
<div><div><div>Höheneinstellung der Rückenlehne aus Buchensperrholz, komplett mit flexibler, formstabiler und selbstverlöschender Polyurethan-Polsterung bezogen.</div></div></div>
<div><div><div>Lendenwirbelstütze aus Polypropylen.</div></div></div>

<div><i>Zero7</i></div>
<div><div><div>– Sitzfläche aus Buchensperrholz; Korpus aus schwarzem, stoß- und kratzfestem Polypropylen; Polsterung aus flexiblem, formstabilem und selbstverlöschendem Polyurethan.</div></div></div>
<div><div><div>– Sichtbare Rückenlehne aus schwarzem, grauem oder weißem Polypropylen.</div></div></div>
<div><div><div>Lendenwirbelstütze aus ABS mit einem weichen, schwarzen Polyurethanbezug.</div></div></div>
<div><div><div>– Rückenlehen aus schwarzem, grauem oder weißem Polypropylen mit flexibler, formstabiler und selbstverlöschender Polyurethan-Polsterung.</div></div></div>
<div><div><div>Lendenwirbelstütze aus Polypropylen.</div></div></div>
<div><div><div>– Rückenlehne mit schwarzem Nylonrahmen und einem Bezug aus Polyester-Netzgewebe.</div></div></div>
<div><div><div>Lendenwirbelstütze aus schwarzem aufgeschäumten Polyethylen.</div></div></div>

<div>Grundmodelle</div>
<div><i>Zero7 Elegant</i></div>
<div><div><div>– Fünfstrahliger Fuß aus Polyamid, Stahl und Polypropylen oder aus poliertem Aluminium mit Rollen oder festen Standfüßen.</div></div></div>
<div><div><div>Die selbstbremsenden Schwenkräder bestehen aus Nylon mit Polyurethan-Lauffläche.</div></div></div>
<div><div><div>Die festen</div></div></div>

<div>Standfüße bestehen aus Nylon.</div>
--

<div><i>Zero7</i></div>
<div><div><div>– Fünfarmiges Fußkreuz mit Rollen oder Standfuß.</div></div></div>
<div><div><div>Das Grundgestell besteht aus mit schwarzem oder grauem Glasfasergewebe verstärktem Nylon oder poliertem Aluminium Standfüßen.</div></div></div>
<div><div><div>Die selbstbremsenden Schwenkräder bestehen aus Nylon mit Polyurethan-Lauffläche.</div></div></div>
<div><div><div>Die festen Standfüße bestehen aus Nylon.</div></div></div>
<div><div><div>– Standfuß mit vier Beinen aus schwarz lackiertem oder verchromtem Stahlrohr.</div></div></div>

<div>Funktionen</div>
<div><i>Zero7 Elegant</i></div>
<div><div><div>– Höheneinstellung der Rückenlehne.</div></div></div>

<div><i>Alle Modelle mit Ausnahme der Versionen mit festem Standfuß</i></div>
<div><div><div>– Sitzhöhenverstellung mit Gasdruckfeder.</div></div></div>
<div><div><div>– Höhenverstellung der Lendenwirbelstütze.</div></div></div>
<div><div><div>(6)</div></div></div>
<div><div><div>– Die Modelle mit drehbarem Sitz sind auch schwingbar mit mehreren synchronen Multiblock-Bewegungen, einem synchronen Multiblock mit Sitztiefenverstellung, einem synchronen Multiblock mit Tiefenverstellung und einer negativen Sitzneigung erhältlich.</div></div></div>
<div><div><div>Sie verfügen alle über eine Verriegelung in mehreren Positionen, eine Schwingungsverstellung und ein Sicherheits-Rückschwingsperrsystem.</div></div></div>

<div>Sonderzubehörteile</div>
<div><i>Zero7 Elegant</i></div>
<div><div><div>– Höhenverstellbare 1D-Armlehnen aus weißem oder schwarzem Polyamid.</div></div></div>
<div><div><div>– Verstellbare Armlehnen aus weißem oder schwarzem Polyamid in der Ausführung 4D.</div></div></div>
<div><div><div>Bezug aus schwarzem „Soft-Touch“-Elastomer oder Polsterung.</div></div></div>
<div><div><div>– Kopfstütze aus Polypropylen, höhen- und neigungsverstellbar, überzogen und gepolstert mit flexiblem, selbstverlöschendem Polyurethan.</div></div></div>
<div><div><div>– Sitzkissen mit Memory-Schaumstoff.</div></div></div>

<div><i>Zero7</i></div>
<div><div><div>– Kopfstütze aus Polypropylen, überzogen und gepolstert mit flexiblem, selbstverlöschendem Polyurethan.</div></div></div>
<div><div><div>– Armlehnen: fest aus schwarzem, grauem oder weißem Polypropylen oder verstellbar in 4D mit schwarzem oder grauem Nylonrahmen und Komfortbezug aus „Soft-Touch“-Elastomer.</div></div></div>
<div><div><div>(1–4)</div></div></div>
<div><div><div>– Sitzpolster mit Ziernähten.</div></div></div>
<div><div><div>– Sitzpolster mit integrierten Mikrofedern (nur bei Modell mit Ziernähten).</div></div></div>
<div><div><div>(5)</div></div></div>
<div><div><div>– Höhenverstellbare Fußstützen aus verstärktem Nylon.</div></div></div>

ES

Materiales*Zero7 Elegant*

– Placa bajo el asiento y asiento en polipropileno con acolchado de resinas expandidas indeformables autoextinguibles. Respaldo con ajuste de altura de madera contrachapada de haya totalmente tapizado, con relleno de poliuretano flexible, indeformable y autoextinguible. Soporte lumbar de polipropileno

Zero7

– Asiento de polipropileno reforzado con dos barras tubulares cuadradas; cuerpo de polipropileno negro, gris o blanco, resistente a golpes y arañazos; relleno de poliuretano flexible, indeformable y autoextinguible.
– Respaldo de polipropileno visto negro, gris o blanco. Soporte lumbar de ABS tapizado con poliuretano blando negro.
– Respaldo de polipropileno negro, gris o blanco con tablero acolchado con poliuretano flexible, indeformable y autoextinguible. Soporte lumbar de polipropileno.
– Respaldo fabricado con estructura de nailon negro y tapizado con malla de poliéster. Soporte lumbar de polietileno negro soplado.

Tipos de base*Zero7 Elegant*

– Base de cinco radios de poliamida negra, acero y polipropileno negro o en aluminio pulido con ruedas o pies fijos. Las ruedas pivotantes autofrenantes son de nailon con banda de rodadura de poliuretano. Los pies fijos son de nailon.

Zero7

– Base de cinco radios con ruedas o pies. La base es de nailon reforzado con fibra de vidrio negra o gris, o de aluminio pulido.
Las ruedas pivotantes autofrenantes son de nailon con banda de rodadura de poliuretano. Los pies fijos son de nailon.
– Base fija con cuatro patas, con tubos de acero pintados de negro o cromados.

Mecanismos*Zero7 Elegant*

– Respaldo con ajuste de altura regulable.

Todos los modelos excepto las versiones con base fija

– Altura del asiento regulable con pistón a gas.
– Altura del soporte lumbar regulable. (6)
– La silla de los modelos con asiento giratorio puede oscilar con movimientos sincron multiblock, sincron multiblock con ajuste de profundidad del asiento, sincron multiblock con ajuste de profundidad del asiento y con inclinación negativa,

todos con bloqueo en diferentes posiciones, regulación de la oscilación y sistema de seguridad antirretorno.

Accesorios opcionales*Zero7 Elegant*

– Brazos 1D de altura regulable en poliamida blanca o negra.
– Brazos regulables de poliamida blanca o negra en la versión 4D. Cubierta en elastómero "soft touch" negro o tapizada.
– Reposacabezas de polipropileno, altura e inclinación regulables, tapizado y relleno de poliuretano flexible autoextinguible.
– Cojín del asiento con Memory Foam.

Zero7

– Reposacabezas de polipropileno tapizado y relleno de poliuretano flexible autoextinguible.
– Brazos fijos de polipropileno negro, gris o blanco, o regulables en 4D con estructura de nailon negro o gris y cubierta de apoyo confort de elastómero «soft touch». (1-4)
– Cojín del asiento con costuras.
– Cojín del asiento con micromuelles integrados (solo con costuras). (5)
– Reposapiés de altura regulable de nailon reforzado.



EN – Warranty IT – Garanzia
FR – Garantie DE – Garantie
ES – Garantía

Paddle



Studio Ares



Paddle

mod. 6#16

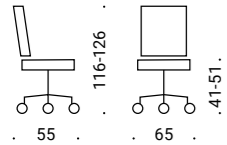
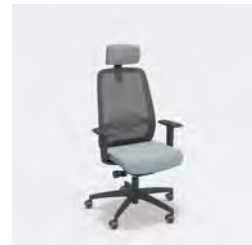

mod. 6#18

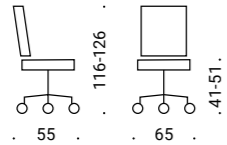
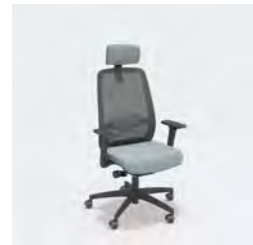

mod. 6#36

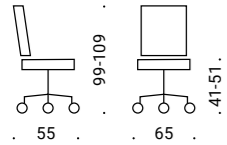
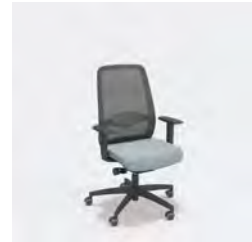

mod. 6#38

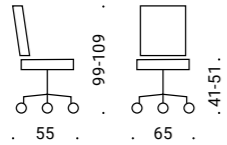
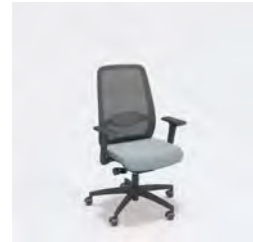

mod. 6#31

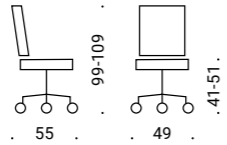
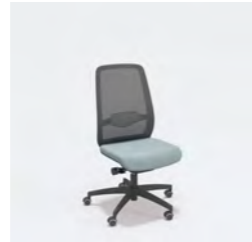

Models

EN — # Plastics IT — # Plastiche FR — # Plastiques DE — # Kunststoffe ES — # Plásticos

4 White 3 Black



Paddle





EN

Materials

– PPK20 seat with PP polypropylene under seat and padding in non-deformable self-extinguishing expanded resins with differentiated density.

– Backrest in white PAFV polyamide with fire retardant net. Lumbar support adjustable in height or depth.

Base types

– Five-spoke base in polyamide, or polished aluminium, with castors or fixed feet. Self-braking swivel castors made of nylon with polyurethane tread. Fixed feet in nylon.

Mechanisms

– Seat height adjustment with gas cylinder. – Height (1) or depth (2) adjustment of lumbar support.

– Seat tilt with Synchron multiblock mechanism, Synchron multiblock with adjustable seat depth, Synchron multiblock with adjustable seat depth and forward tilt, all with multi-position locking, tilt adjustment, and anti-return safety system.

Optional accessories

– Height-adjustable 1D armrests in black or white polyamide. (3)

– Adjustable polyamide armrests, white or black in the 5D version. (4-8) With black “soft touch” elastomer cover or upholstered.

– Headrest in white or black polyamide with padding in non-deformable self-extinguishing expanded resin. (9)

– Seat cushion with Memory Foam. (10)

IT

Materiali

– Sedile in PPK20 con sotto sedile in polipropilene PP e. Imbottiture in resine espanse indeformabili autoestinguenti a densità differenziata.

– Schienale in poliammide PAFV bianco o nero con rete ignifuga. Supporto lombare regolabile in altezza o in profondità.

Tipologie di base

– Base a cinque razze in poliammide o in alluminio lucidato, con ruote o piedini fissi. Le ruote piroettanti autofrenanti sono in nylon con battistrada in poliuretano. I piedini fissi sono in nylon.

Meccanismi

– Regolazione in altezza della seduta con pompa a gas. – Regolazione in altezza (1) o profondità (2) del supporto lombare. – Oscillazione della poltrona con movimenti sincron multiblock, sincron multiblock con regolazione della

profondità del sedile, sincron multiblock con regolazione in profondità del sedile, tutti con bloccaggio in più posizioni, regolazione dell'oscillazione e sistema di sicurezza anti-ritorno.

Accessori opzionali

– Braccioli 1D regolabili in altezza in poliammide nero o bianco. (3)

– Braccioli regolabili in poliammide bianco o nero nella versione 5D. (4-8) Copertura in elastomero “soft touch” nero o tappezzata.

– Poggiatesta in poliammide bianco o nero con imbottitura in resine espanse indeformabili autoestinguenti. (9)

– Cuscino sedile con Memory Foam. (10)

FR

Matériaux

– Siège en PPK20 avec partie sous l'assise en polypropylène PP et rembourrage en résine expansées indéformables autoextinguibles à densité différenciée.

– Dossier en polyamide PAFV blanc ou noir avec maille ignifuge.

Support lombaire réglable en hauteur et en profondeur.

Types de piètement

– Piètement à cinq branches en polyamide, ou en aluminium poli avec roulettes ou pieds fixes.

Les roulettes pivotantes autofreinantes sont en nylon avec chape en polyuréthane. Les pieds fixes sont en nylon.

Mécanismes

– Réglage en hauteur du siège avec vérin à gaz.

– Support lombaire réglable en hauteur (1) et en profondeur (2).

– Oscillation du fauteuil avec des mouvements mécanisme synchrone multiblock, mécanisme synchrone multiblock avec réglage de la profondeur de l'assise, mécanisme synchrone multiblock avec réglage de la profondeur et mécanisme d'assise négative, tous avec blocage possible dans plusieurs positions, réglage de l'oscillation et système de sécurité anti-retour.

Accessoires en option

– Accoudoirs 1D réglables en hauteur en polyamide blanc ou noir. (3)

– Accoudoirs réglables en polyamide blanc ou noir dans la version 5D. (4-8) Revêtement en élastomère « soft touch » noir ou tapissé.

– Appui-tête en polyamide blanc ou noir avec rembourrage en résines expansées indéformables autoextinguibles. (9)

– Coussin siège avec mousse à mémoire de forme. (10)

DE

Materialien

– Sitzfläche aus PPK20 mit Untersitz aus Polypropylen PP und Polsterung aus nicht verformbarem selbstverlöschendem Harzschaum mit unterschiedlichen Dichten.

– Rückenlehne aus weißem oder schwarzem PAFV-Polyamid mit feuerfestem Netzgewebe.

In Höhe und Tiefe verstellbare Lendenstütze.

Grundmodelle

– Fünfstrahliger Fuß aus Polyamid oder aus poliertem Aluminium mit Rollen oder festen Standfüßen.

Die selbstbremsenden Schwenkräder bestehen aus Nylon mit Polyurethan-Laufläche. Die festen Standfüße bestehen aus Nylon.

Funktionen

– Sitzhöhenverstellung mit Gasdruckfeder.

– Höhen- und Tiefenverstellung der Lendenstütze. (1-2)

– Drehbarer Sitz mit synchronen Multiblock-Bewegungen, einem synchronen Multiblock mit Sitztiefenverstellung, einem synchronen Multiblock mit Tiefenverstellung und einer negativen Sitzneigung, alle verfügen über eine Verriegelung in mehreren Positionen, eine Schwingungsverstellung und ein Sicherheits-Rückschwingsperrsystem.

Sonderzubehörteile

– Höhenverstellbare 1D-Armlehnen aus weißem oder schwarzem Polyamid. (3)

– Verstellbare Armlehnen aus weißem oder schwarzem Polyamid in der Ausführung 5D. (4-8)

Bezug aus schwarzem „Soft-Touch“-Elastomer oder Polsterung.

– Kopfstütze aus weißem oder schwarzem Polyamid mit Polsterung aus nicht verformbarem selbstverlöschendem Harzschaum. (9)

– Sitzkissen mit Memory-Schaumstoff. (10)

ES

Materiales

– Asiento en PPK20 con placa bajo el asiento en polipropileno PP y acolchados en resinas expandidas indeformables autoextinguibles de densidad diferenciada.

– Respaldo en poliamida PAFV blanco o negro con malla ignífuga.

Soporte lumbar con ajuste en altura o profundidad.

Tipos de base

– Base de cinco radios de poliamida o en aluminio pulido con ruedas o pies fijos. Las ruedas pivotantes autofrenantes son de nailon con banda de rodadura en poliuretano. Los pies fijos son de nailon.

Mecanismos

– Altura del asiento regulable con pistón a gas.

– Soporte lumbar regulable en altura (1) o profundidad (2).

– Oscilación de la silla con movimientos sincron multiblock, sincron multiblock con ajuste de profundidad del asiento, sincron multiblock con ajuste de profundidad del asiento y con inclinación negativa, todos con bloqueo en diferentes posiciones, regulación de la oscilación y sistema de seguridad antirretorno.

Accesorios opcionales

– Brazos 1D de altura regulable en poliamida blanca o negra. (3)

– Brazos regulables de poliamida blanca o negra en la versión 5D. (4-8) Cubierta en elastómero “soft touch” negro o tapizada.

– Reposacabezas en ABS y poliamida blanco o negro con acolchado en resinas expandidas indeformables autoextinguibles. (9)

– Cojín del asiento con Memory Foam. (10)

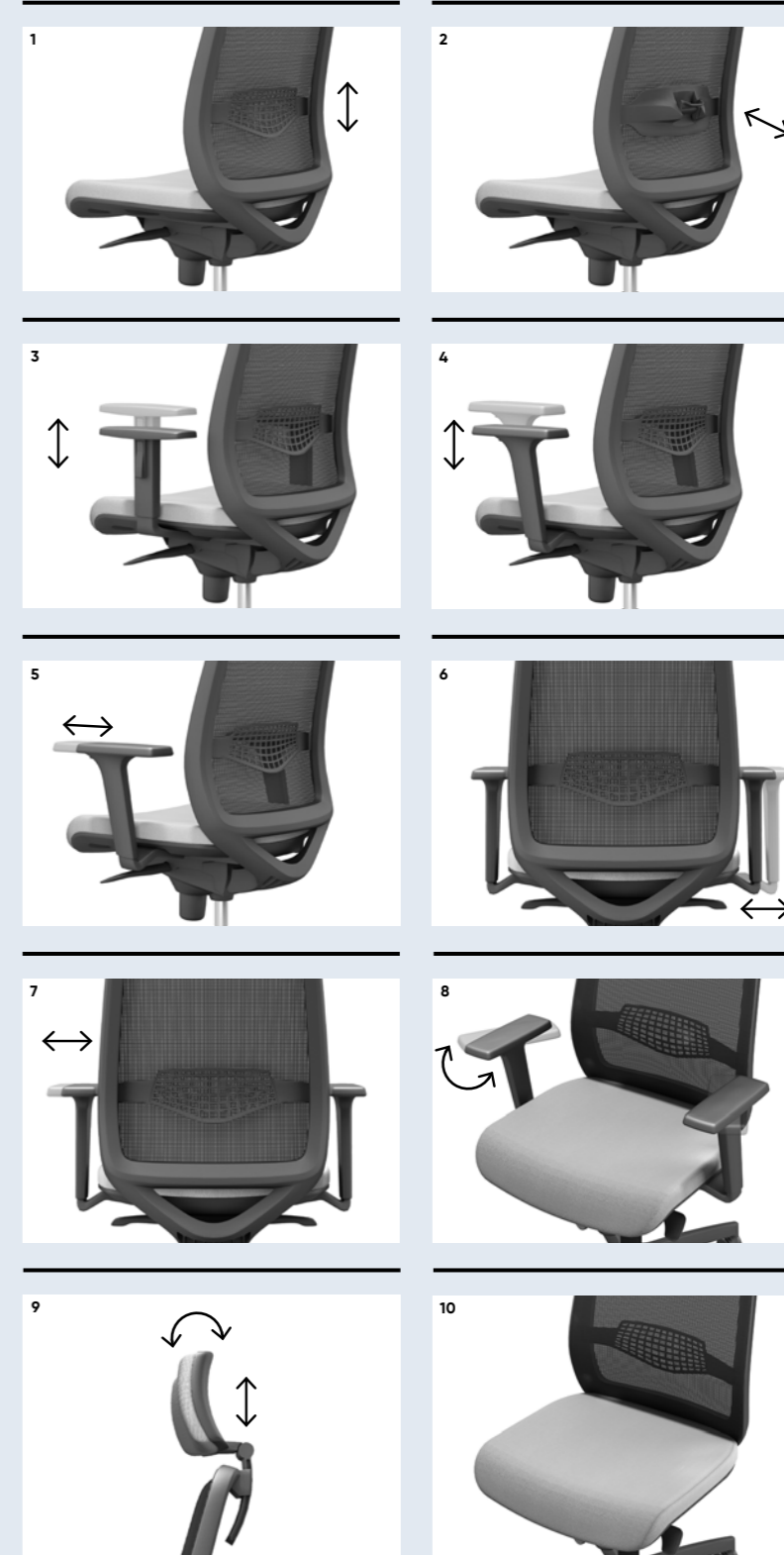

EN – Warranty IT – Garanzia
FR – Garantie DE – Garantie
ES – Garantía

Smart



Studio Ares

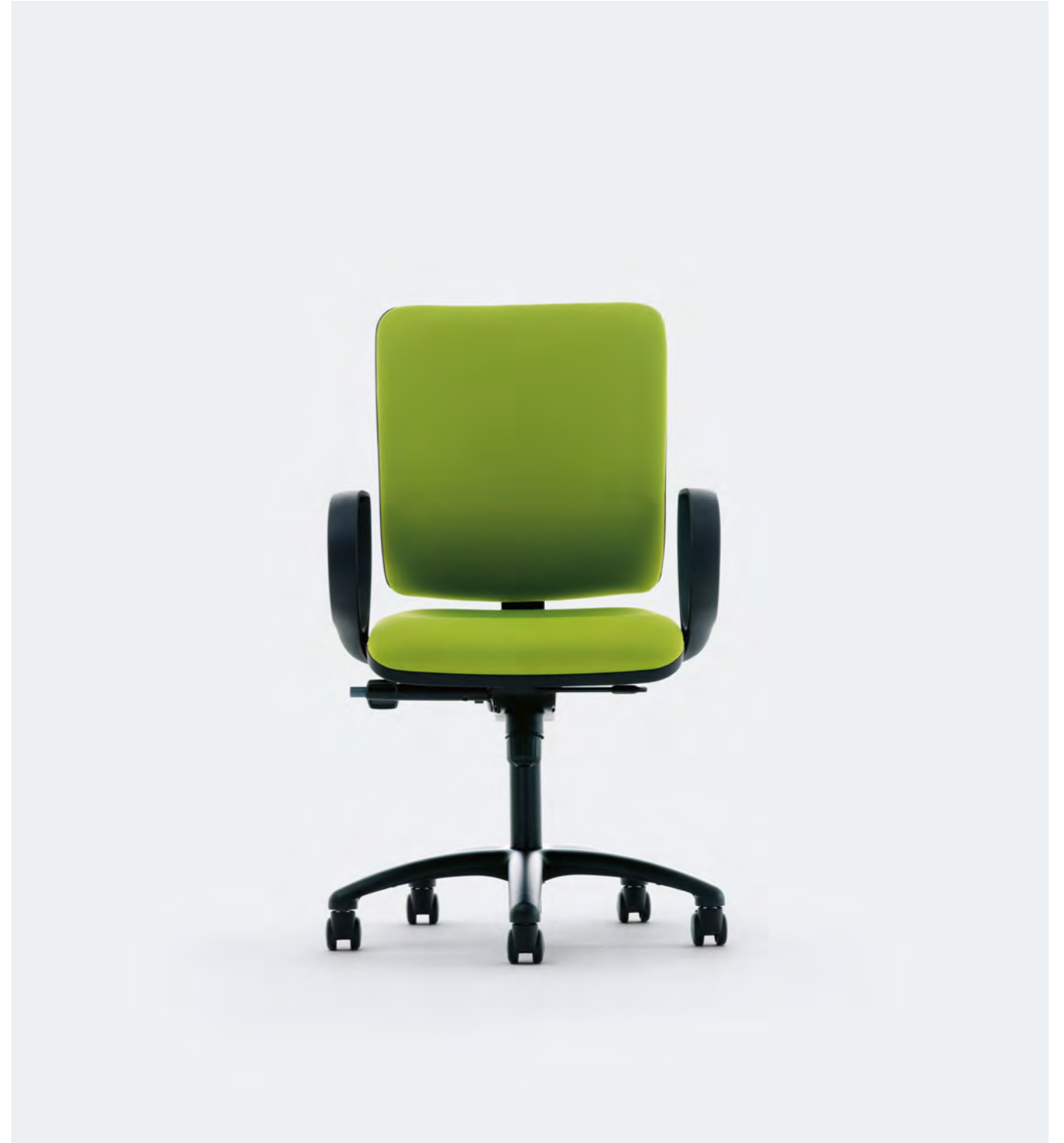

Smart

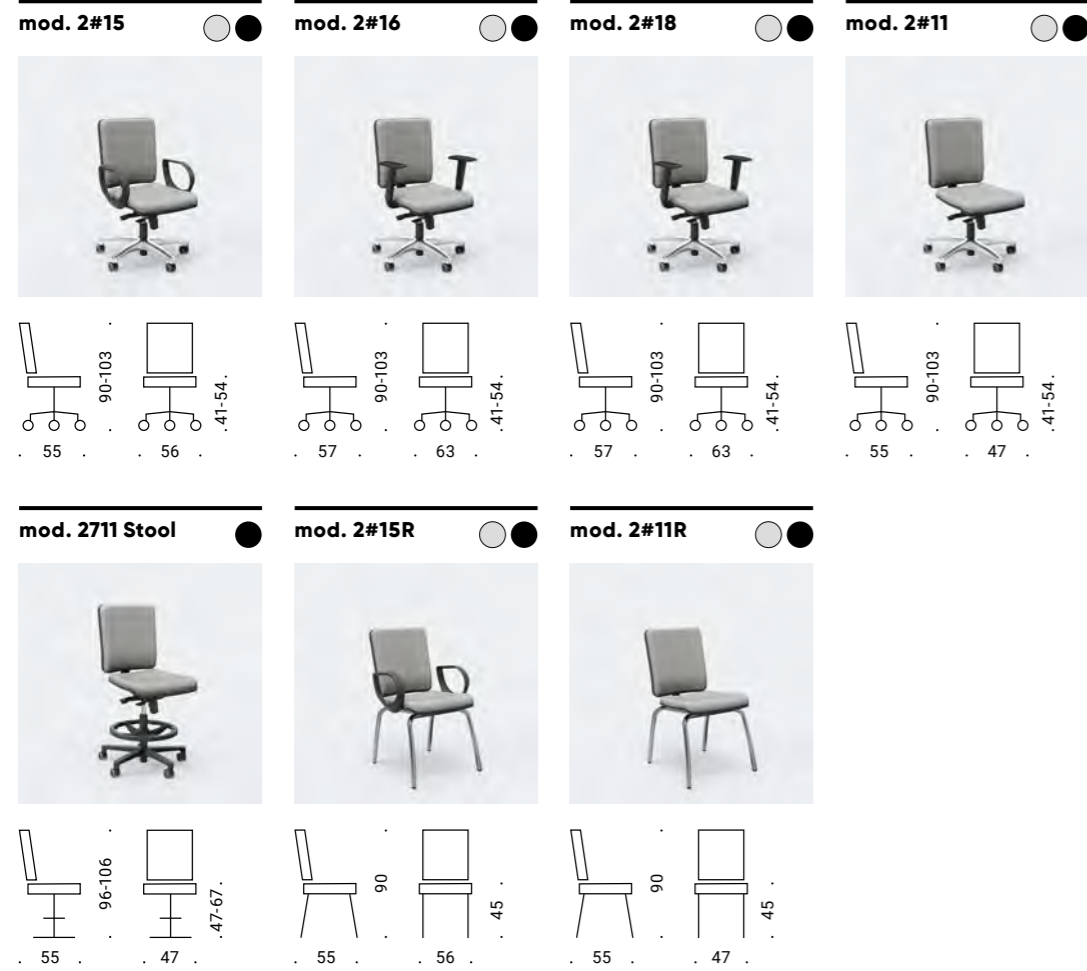

Models



Smart

EN — # Plastics IT — # Plastiche FR — # Plastiques DE — # Kunststoffe ES — # Plásticos

8 Grey 7 Black

EN

Materials

– Seat in birch plywood and backrest in reinforced polypropylene, padded with self-extinguishing shape-retaining differential density synthetic foam. Cover shell in black or grey impact and scratch resistant polypropylene.

Base types

– Four-leg base in black coated tubular steel.
– Five-spoke base with castors or feet. The base is in black or grey fibreglass reinforced nylon, or polished aluminium. The self-braking swivel castors are in nylon for soft flooring or with soft polyurethane tread for hard flooring. The fixed feet are in reinforced nylon.

Mechanisms

– Seat height adjustment with gas cylinder.
– Up&down backrest height adjustment. (1)
– Seat tilt with Synchron multiblock mechanism and Synchron multiblock with adjustable seat depth, with multi-position locking, tilt adjustment, and anti-return safety system.

Optional accessories

– Fixed armrests in black or grey injection moulded fiberglass reinforced nylon.
– Adjustable 2D armrests with black coated steel frame and black polypropylene upholstery.
– Adjustable 4D armrests with black or grey nylon frame and soft polyurethane upholstery. (2–5)
– Height adjustable footrest in reinforced black polypropylene.

IT

Materiali

– Sedile in legno multistrato di betulla e schienale in polipropilene rinforzato, imbottiture in resine espanse indeformabili autoestinguenti a densità differenziata. Scocche di copertura in polipropilene antiurto e antigraffio di colore nero o grigio.

Tipologie di base

– Base fissa a quattro gambe in tubolare d'acciaio verniciato nero.
– Base a cinque razze con ruote o piedini. La base è in nylon rinforzato con fibra di vetro nero o grigio, o in alluminio lucidato. Le ruote piroettanti autofrenanti sono in nylon per suolo morbido o con battistrada in poliuretano morbido per suolo duro. I piedini fissi sono in nylon rinforzato.

Meccanismi

– Regolazione in altezza della seduta con pompa a gas.

– Regolazione in altezza dello schienale del tipo up&down. (1)
– Oscillazione della poltrona con movimenti sincron multiblock e sincron multiblock con regolazione della profondità del sedile, con bloccaggio in più posizioni, regolazione dell'oscillazione e sistema di sicurezza anti-ritorno.

Accessori opzionali

– Braccioli fissi in nylon caricato con fibra di vetro stampato a iniezione, neri o grigi.
– Braccioli regolabili con struttura in acciaio verniciato nero e coperture in polipropilene nero.
– Braccioli regolabili 4D con struttura in nylon nero o grigio e copertura in poliuretano morbido. (2–5)
– Poggiapiedi regolabile in altezza in polipropilene nero rinforzato.

FR

Matériaux

– Assise en bois de hêtre multiplis et dossier en polypropylène renforcé, rembourrages en résines expansées indéformables autoextinguibles à densité différenciée. Structures de couverture en polypropylène antichoc et anti-rayures de couleur noire ou grise.

Types de piètement

– Piètement à quatre jambes en tubes d'acier verni noir.
– Piètement à cinq branches avec roulettes ou pieds. Le piètement est en nylon renforcé de fibres de verre noir ou gris, ou en aluminium poli. Les roulettes pivotantes autofreinantes sont en nylon pour sol souple ou avec chape en polyuréthane souple pour sol dur. Les pieds fixes sont en nylon renforcé.

Mécanismes

– Réglage en hauteur du siège avec vérin à gaz.
– Réglage hauteur dossier type up&down. (1)
– Oscillation du fauteuil avec des mouvements mécanisme synchrone multi-bloc et mécanisme synchrone multi-bloc avec réglage de la profondeur de l'assise, avec blocage possible dans plusieurs positions, réglage de l'oscillation et système de sécurité anti-retour.

Accessoires en option

– Accoudoirs fixes en nylon renforcé de fibres de verre moulé par injection, noirs ou gris.
– Accoudoirs réglables 2D avec structure en acier verni noir et couvertures en polypropylène noir.
– Accoudoirs réglables 4D avec structure en nylon noir ou gris et couverture en polyuréthane souple. (2–5)

– Repose-pieds réglable en hauteur en polypropylène noir renforcé.

DE

Materialien

– Sitz aus Birkensperrholz und Rückenlehne aus verstärktem Polypropylen, Polsterung aus selbstverlöschendem, formstabilem Kunstharzschäum mit unterschiedlicher Dichte. Bezüge aus schwarzem oder grauem, stoßfestem und kratzfestem Polypropylen.

Grundmodelle

– Standfuß mit vier Beinen aus schwarz lackiertem oder verchromtem Stahlrohr.
– Fünfarmiges Fußkreuz mit Rollen oder Standfüßen. Das Grundgestell besteht aus mit schwarzem oder grauem Glasfasergewebe verstärktem Nylon oder poliertem Aluminium. Die selbstbremsenden Lenkrollen bestehen für weiche Böden aus Nylon. Mit einer weichen Polyurethan-Laufläche sind sie auch für harte Böden geeignet. Die Standfüße sind aus verstärktem Nylon gefertigt.

Funktionen

– Sitzhöhenverstellung mit Gasdruckfeder.
– Rückenlehne mit „Up & Down“-Höhenverstellung. (1)
– Schwingbarer Sitz mit synchronen Multiblock-Bewegungen und einem synchronen Multiblock mit Sitztiefenverstellung, mit einer Verriegelung in mehreren Positionen, einer Schwingungsverstellung und einem Sicherheits-Rückschwingsperrsystem.

Sonderzubehörteile

– Armlehnen: fest aus schwarzem oder grauem, spritzgegossenem, glasfaserverstärktem Nylon.
– Armlehnen: in zwei Ebenen verstellbar aus schwarz lackiertem, verchromtem Stahlrahmen und Bezügen aus schwarzem Polypropylen.
– Armlehnen: in vier Ebenen verstellbar aus schwarzem oder grauem Nylonrahmen und mit weichem Polyurethanbezug. (2–5)
– Höhenverstellbare Fußstützen aus verstärktem Polypropylen.

ES

Materiales

– Asiento en multicapa de abedul y respaldo de polipropileno reforzado, acolchados con resinas expandidas autoextinguibles indeformables de diferentes densidades. Cubiertas de polipropileno negro o gris a prueba de golpes y arañazos.

Tipos de base

– Base fija de cuatro patas, en tubular de acero pintado en negro.
– Base de cinco radios con ruedas o pies. La base es de nailon reforzado con fibra de vidrio negra o gris, o de aluminio pulido. Las ruedas, giratorias y autofrenantes, están fabricadas en nailon para suelos blandos y con banda de poliuretano blando para suelos duros. Los pies fijos son de nailon reforzado.

Mecanismos

– Altura del asiento regulable con pistón a gas.
– Regulación altura tipo up&down. (1)
– Oscilación de la silla con movimientos sincron multiblock y sincron multiblock con ajuste de profundidad del asiento, con bloqueo en diferentes posiciones, regulación de la oscilación y sistema de seguridad antirretorno.

Accesorios opcionales

– Brazos fijos de nailon reforzado con fibra de vidrio moldeado por inyección, negros o grises.
– Brazos regulables 2D con estructura de acero pintada de negro y cubiertas de polipropileno negro.
– Brazos regulables 4D con estructura de nailon negro o gris y cubierta de poliuretano blando. (2–5)
– Reposapiés de altura regulable de polipropileno negro reforzado.



EN – Warranty IT – Garanzia
FR – Garantie DE – Garantie
ES – Garantía

Waiting

PF3 – p. 126

Naxos – p. 134

Mya – p. 144

Jolly – p. 152

Ventuno – p. 162

PF3

Pininfarina

PF3



PF3
pininfarina

mod. 6001R1

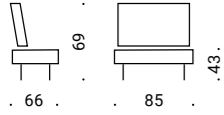
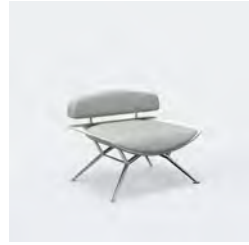

mod. 6001R2

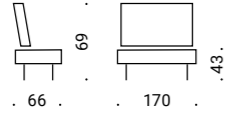

mod. 60B1R2

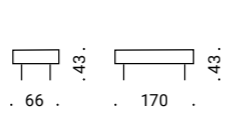

Models



PF3

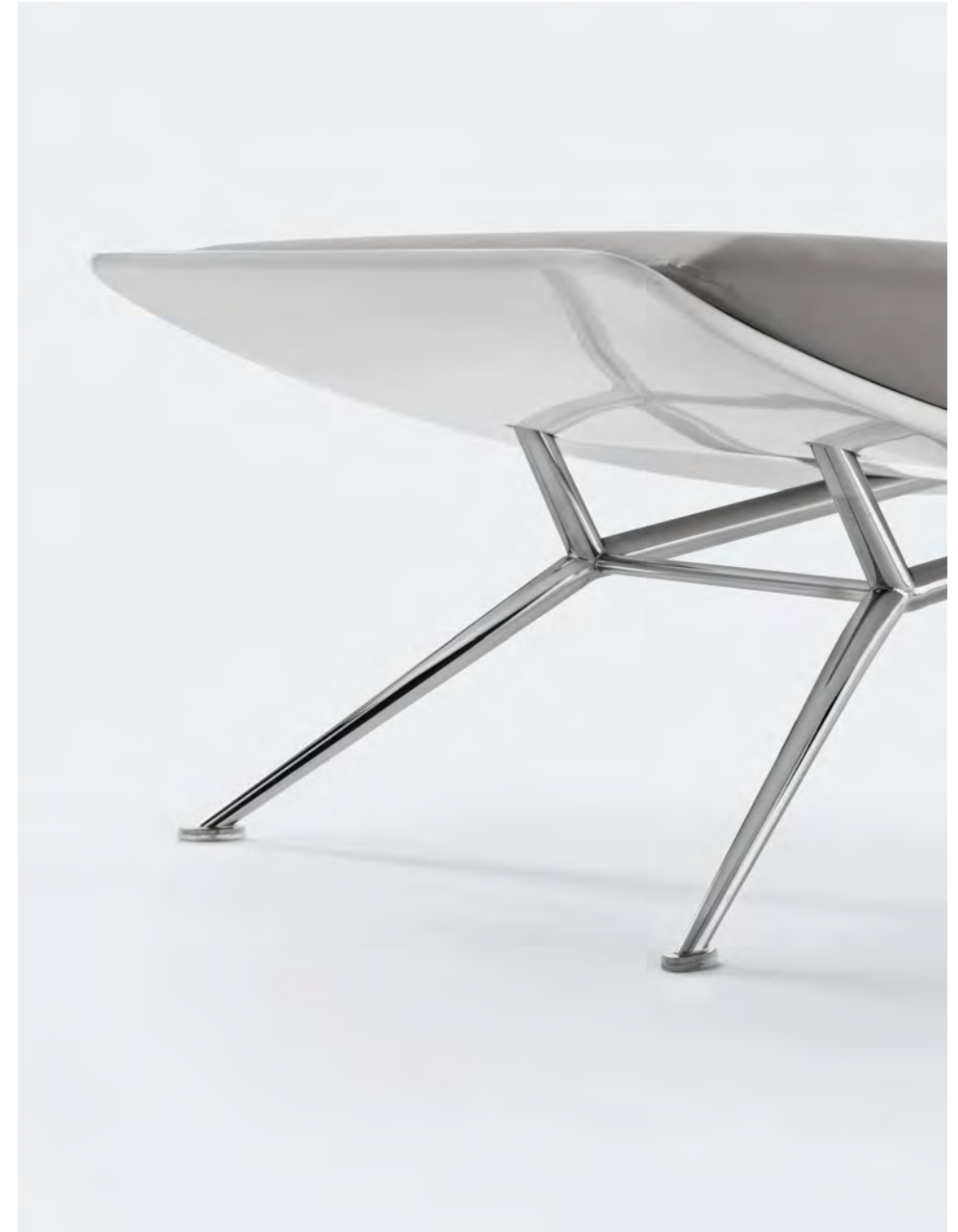

**EN****Materials**

– Seat in white fibreglass composite with padding in self-extinguishing cold-moulded polyurethane and beech insert. Backrest in beech plywood with padding in shape-retaining synthetic foam. Supports in chromed steel.

Types

- 1 seat armchair.
- 2 seat sofa.
- 2 seat sofa without backrest.

IT**Materiali**

– Sedile in composito di fibra di vetro di colore bianco con imbottitura in poliuretano autoestinguento schiumato a freddo e inserto in legno di faggio. Schienale in legno multistrato di faggio con imbottitura in resine espanse indeformabili. Supporti in acciaio cromato.

Tipologie

- Poltrona 1 posto.
- Poltrona 2 posti.
- Poltrona 2 posti senza schienale.

FR**Matériaux**

– Assise en composite de fibres de verre de couleur blanche avec rembourrage en mousse de polyuréthane autoextinguible moulée à froid et insert en bois de hêtre. Dossier en bois de hêtre multiplis avec rembourrage en résines expansées indéformables. Supports en acier chromé.

Types

- Fauteuil 1 place.
- Fauteuil 2 places.
- Fauteuil 2 places sans dossier.

DE**Materialien**

– Sitz aus weißem Glasfaserverbund mit kaltgeschäumter, selbstverlöschender Polyurethan-Polsterung und Buchenholzeinlage. Rückenlehne aus Buchensperrholz mit Polsterung aus selbstverlöschendem, formstabilem Kunstharzschaum. Halterungen aus verchromtem Stahl.

Typen

- Einsitzer-Bank.
- Zweisitzer-Bank.
- Zweisitzer-Bank ohne Rückenlehne.

ES**Materiales**

– Asiento de material compuesto de fibra de vidrio blanca con acolchado de poliuretano autoextinguible espumado en frío e inserción de madera de haya. Respaldo en multicapa de haya con acolchado de resinas expandidas indeformables. Soportes de acero cromado.

Tipos

- Sillón 1 plaza.
- Sillón 2 plazas.
- Sillón 2 plazas sin respaldo.



EN – Warranty IT – Garanzia
FR – Garantie DE – Garantie
ES – Garantía

Naxos



BaccoliniDesign



Naxos

mod. 3805R1

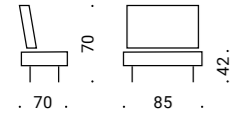

mod. 3805R2

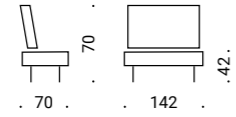

mod. 3805R3

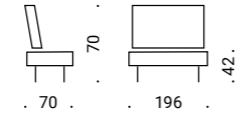

mod. 3892R1

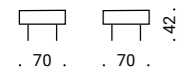

mod. 3890NN1



mod. 3890NN1

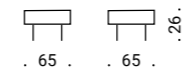

mod. 3892R2

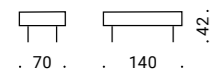

mod. 3890NN2



mod. 3890NN2



Models



Naxos





**EN****Materials***Upholstered*

– Frame in solid wood with particle board supports. Upholstered parts in countered polyurethane foams with differentiated density with synthetic fibres for improved comfort. Legs in tubular steel coated aluminium grey or chromed.

Side tables

– Top in tempered glass, sand blasted and varnished, option of undershelf in upholstered particle board. Legs in tubular steel coated aluminium grey or chromed.

Types*Upholstered*

- 1 seat armchair.
- 2 seat sofa.
- 3 seat sofa.
- 1 seat pouf.
- 2 seat pouf.

Side tables

- Square table.
- Square table with undershelf.
- Rectangular table.
- Rectangular table with undershelf.

IT**Materiali***Imbottiti*

– Struttura in legno massello con piani in conglomerato ligneo. Imbottiture in resine espanse indeformabili a densità differenziata ricoperte con fibra di resina per un maggior comfort. Gambe in tubolare d'acciaio verniciato grigio alluminio o cromato.

Tavolini

– Piano in vetro temperato, sabbato e verniciato, a scelta con sottopiano in conglomerato ligneo rivestito. Gambe in tubolare d'acciaio verniciato grigio alluminio o cromato.

Tipologie*Imbottiti*

- Poltrona 1 posto.
- Divano 2 posti.
- Divano 3 posti.
- Pouf 1 posto.
- Pouf 2 posti.

Tavolini

- Tavolo quadrato.
- Tavolo quadrato con sottopiano.
- Tavolo rettangolare.
- Tavolo rettangolare con sottopiano.

FR**Matériaux***Rembourrés*

– Structure en bois massif avec plans en bois aggloméré. Rembourrage en résines expansées indéformables à densité différenciée recouvertes de fibres de résine pour un confort accru. Jambes en tubes d'acier verni gris aluminium ou chromé.

Tables basses

– Plan en verre trempé, sablé et peint, au choix avec étagère inférieure en bois aggloméré revêtu. Jambes en tubes d'acier verni gris aluminium ou chromé.

Types*Rembourrés*

- Fauteuil 1 place.
- Canapé 2 places.
- Canapé 3 places.
- Pouf 1 place.
- Pouf 2 places.

Tables basses

- Table carrée.
- Table carrée avec étagère inférieure.
- Table rectangulaire.
- Table rectangulaire avec étagère inférieure.

DE**Materialien***Gepolstert*

– Massivholzstruktur mit Platten aus Schichtholz. Polsterung aus unverformbarem Harzschaum mit unterschiedlicher Dichte, der für mehr Komfort mit Kunstharzfasern überzogen ist. Beine aus aluminiumgrau lackiertem oder verchromtem Stahlrohr.

Couchtische

– Platte aus gehärtetem Glas, sandgestrahlt und lackiert, optional mit Unterplatte aus beschichtetem Schichtholz. Beine aus aluminiumgrau lackiertem oder verchromtem Stahlrohr.

Typen*Gepolstert*

- Einsitzer-Bank.
- Zweisitzer-Sofa.
- Dreisitzer-Sofa.
- Einsitzer-Pouf.
- Zweisitzer-Pouf.

Couchtische

- Quadratischer Tisch.
- Quadratischer Tisch mit Unterplatte.
- Rechteckiger Tisch.
- Rechteckiger Tisch mit Unterplatte.

ES**Materiales***Acolchados*

– Estructura de madera maciza con tableros de aglomerado. Acolchado en resinas expandidas indeformables de diferentes densidades recubiertas con fibra de resina para un mayor confort. Patas en tubular de acero pintado en gris aluminio o cromadas.

Mesitas

– Tablero de vidrio templado, arenado y pintado, opcionalmente con estante inferior de aglomerado revestido. Patas en tubular de acero pintado en gris aluminio o cromado.

Tipos*Acolchados*

- Sillón 1 plaza.
- Sofá 2 plazas.
- Sofá 3 plazas.
- Puf 1 plaza.
- Puf 2 plazas.

Mesitas

- Mesita cuadrada.
- Mesita cuadrada con estante inferior.
- Mesita rectangular.
- Mesita rectangular con estante inferior.



EN – Warranty IT – Garanzia

FR – Garantie DE – Garantie

ES – Garantía

Mya



BaccoliniDesign



Mya

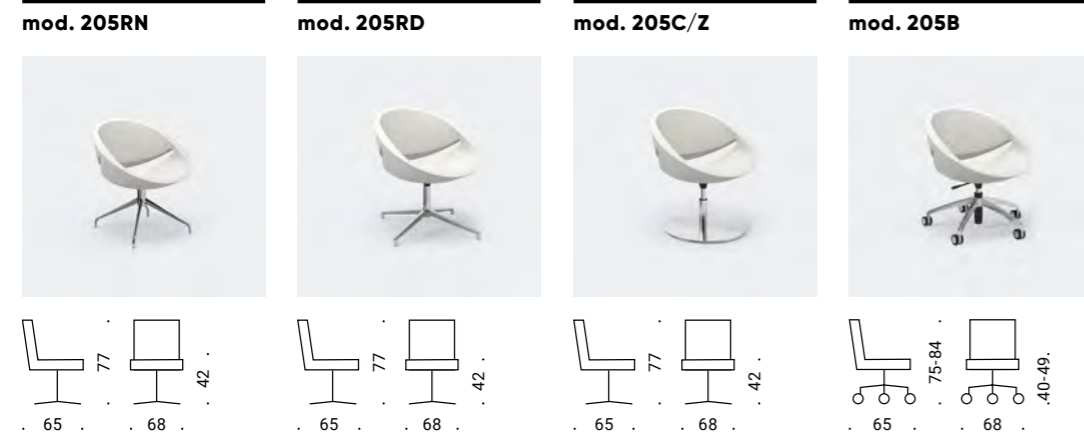

Models



Mya



**EN****Materials**

– Tubular steel frame with padding in self-extinguishing cold-moulded polyurethane.

Base types

– Four-leg base in tubular chromed steel with adjustable feet.
 – Four-spoke base in polished aluminium.
 – Steel disk base surfaced with stainless steel, free swivel or automatic return swivel.
 – Five-spoke base in polished aluminium with castors or feet. The self-braking swivel castors are in nylon for soft flooring or with soft polyurethane tread for hard flooring. The fixed feet are in reinforced nylon.

IT**Materiali**

– Struttura in tubolare d'acciaio con imbottitura in poliuretano autoestinguento schiumato a freddo.

Tipologie di base

– Base a quattro gambe in tubolare d'acciaio cromato con piedini regolabili.
 – Base a quattro razze in alluminio lucidato.
 – Base a disco in acciaio rivestito in acciaio inox, girevole o girevole con ritorno automatico in posizione.
 – Base a cinque razze in alluminio lucidato con ruote o piedini. Le ruote piroettanti autofrenanti sono in nylon per suolo morbido o con battistrada in poliuretano morbido per suolo duro. I piedini fissi sono in nylon rinforzato.

FR**Matériaux**

– Structure en tubes d'acier avec rembourrage en mousse de polyuréthane autoextinguible moulée à froid.

Types de piètement

– Piètement à quatre jambes en tubes d'acier chromé avec pieds réglables.
 – Piètement à quatre branches en aluminium poli.
 – Piètement à disque en acier revêtu inox, pivotant ou pivotant avec repositionnement automatique.
 – Piètement à cinq branches en aluminium poli avec roulettes ou pieds. Les roulettes pivotantes autofreinantes sont en nylon pour sol souple ou avec chape en polyuréthane souple pour sol dur. Les pieds fixes sont en nylon renforcé.

DE**Materialien**

– Gestell aus Stahlrohr mit kaltgeschäumter, selbstverlöschender Polyurethan-Polsterung.

Grundmodelle

– Standfuß mit vier Beinen aus verchromtem Stahlrohr mit einstellbaren Standfüßen.
 – Vierarmiges Fußkreuz aus poliertem Aluminium.
 – Mit Edelstahl beschichteter Stahl-Tellerfuß, drehbar oder drehbar mit automatischer Rückstellfunktion.
 – Fünfarmiges Fußkreuz aus poliertem Aluminium mit Rollen oder festen Standfüßen. Die selbstbremsenden Lenkrollen bestehen für weiche Böden aus Nylon. Mit einer weichen Polyurethan-Laufläche sind sie auch für harte Böden geeignet. Die Standfüße sind aus verstärktem Nylon gefertigt.

ES**Materiales**

– Estructura en tubular de acero con acolchado de poliuretano autoextinguible espumado en frío.

Tipos de base

– Base de cuatro patas, con tubos de acero cromado con pies regulables.
 – Base de cuatro radios de aluminio pulido.
 – Base de disco de acero revestido de acero inoxidable, giratoria o giratoria con retorno automático.
 – Base de cinco radios de aluminio pulido con ruedas o pies. Las ruedas, giratorias y autofrenantes, están fabricadas en nailon para suelos blandos y con banda de poliuretano blando para suelos duros. Los pies fijos son de nailon reforzado.



EN – Warranty IT – Garanzia
 FR – Garantie DE – Garantie
 ES – Garantía

Jolly

BaccoliniDesign

Jolly



mod. 105E

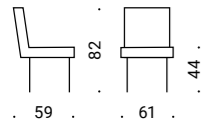
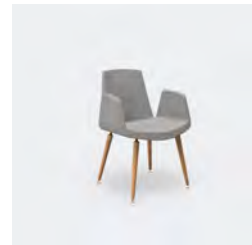

mod. 101E

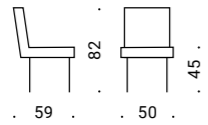
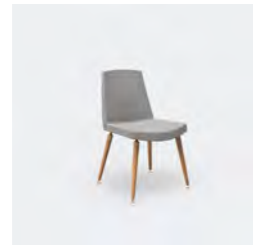

mod. 105W

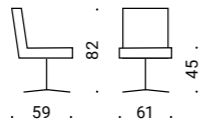

mod. 101W

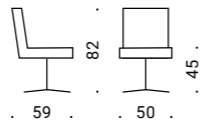

mod. 105CD

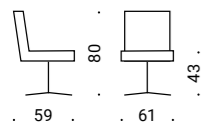
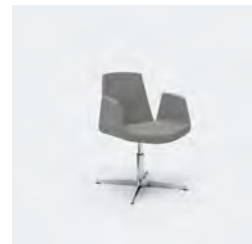

mod. 101CD

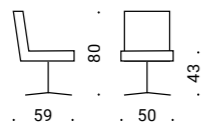
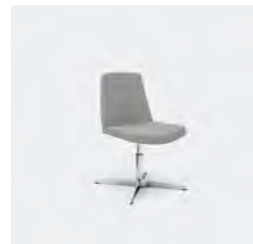

mod. 105C/Z

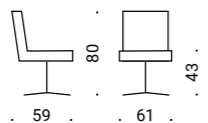
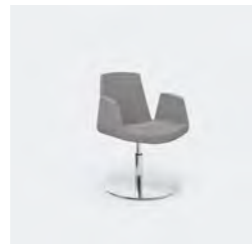

mod. 101C/Z

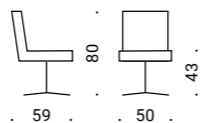
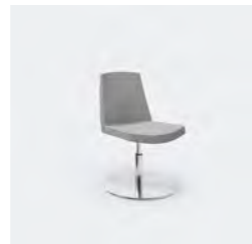

mod. 105B

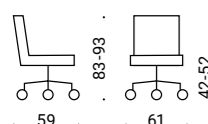
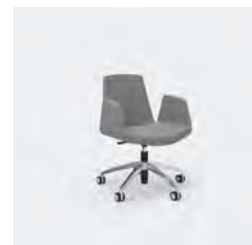

mod. 101BS

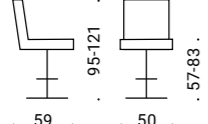
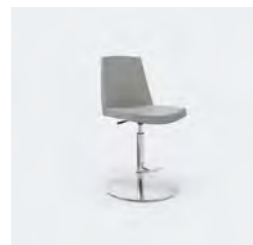

Models



Jolly





EN

Materials

– Tubular steel frame with padding in self-extinguishing cold-moulded polyurethane.

Types

– Small armchair.
– Stool.

Base types

– Four-leg base in natural beech with self-levelling feet.
– Pyramidal base in natural beech wood, with feet.
– Steel disk base surfaced with stainless steel, free swivel or automatic return swivel.
– Five-spoke base in polished aluminium with castors or feet. The self-braking swivel castors are in nylon for soft flooring or with soft polyurethane tread for hard flooring. The fixed feet are in reinforced nylon.

Mechanisms

Only on armchair with five-spoke base and stool
– Seat height adjustment with gas cylinder.

Optional accessories

Small armchair
– Closed armrests, upholstered and padded.

Stool

– Footrest in chromed steel. **(1)**

IT

Materiali

– Struttura in tubolare d'acciaio con imbottitura in poliuretano autoestinguente schiumato a freddo.

Tipologie

– Poltroncina.
– Sgabello.

Tipologie di base

– Base a quattro gambe in legno di faggio naturale con piedini autolivellanti.
– Base piramidale in legno di faggio naturale, con piedini.
– Base a quattro razze in alluminio lucidato.
– Base a disco in acciaio rivestito in acciaio inox, girevole o girevole con ritorno automatico in posizione.
– Base a cinque razze in alluminio lucidato con ruote o piedini. Le ruote piroettanti autofrenanti sono in nylon per suolo morbido o con battistrada in poliuretano morbido per suolo duro. I piedini fissi sono in nylon rinforzato.

Meccanismi

Solo nella poltroncina con base a cinque razze e nello sgabello
– Regolazione in altezza della seduta con pompa a gas.

Accessori opzionali

Poltroncina
– Braccioli chiusi, rivestiti e imbottiti.

Sgabello

– Poggiapiedi in acciaio cromato. **(1)**

FR

Matériaux

– Structure en tubes d'acier avec rembourrage en mousse de polyuréthane autoextinguible moulée à froid.

Types

– Petit fauteuil.
– Tabouret.

Types de piètement

– Piètement à quatre jambes en bois de hêtre naturel avec pieds autonivelants.
– Piètement pyramidal en bois de hêtre naturel, avec pieds.
– Piètement à disque en acier revêtu inox, pivotant ou pivotant avec repositionnement automatique.
– Piètement à cinq branches en aluminium poli avec roulettes ou pieds. Les roulettes pivotantes autofreinantes sont en nylon pour sol souple ou avec chape en polyuréthane souple pour sol dur. Les pieds fixes sont en nylon renforcé.

Mécanismes

Uniquement pour le petit fauteuil avec piètement à cinq branches et pour le tabouret
– Réglage en hauteur du siège avec vérin à gaz.

Accessoires en option

Petit fauteuil
– Accoudoirs fermés, revêtus et rembourrés.

Tabouret

– Repose-pieds en acier chromé. **(1)**

DE

Materialien

– Gestell aus Stahlrohr mit kaltgeschäumter, selbstverlöschender Polyurethan-Polsterung.

Typen

– Armlehnstuhl.
– Hocker.

Grundmodelle

– Standfuß mit vier Beinen aus naturbelassenem Buchenholz

mit selbstausrichtenden Füßen.

– Vierarmiges Fußkreuz aus poliertem Aluminium.
– Mit Edelstahl beschichteter Stahl-Tellerfuß, drehbar oder drehbar mit automatischer Rückstellfunktion.
– Fünfarmiges Fußkreuz aus poliertem Aluminium mit Rollen oder festen Standfüßen. Die selbstbremsenden Lenkrollen bestehen für weiche Böden aus Nylon. Mit einer weichen Polyurethan-Laufläche sind sie auch für harte Böden geeignet. Die Standfüße sind aus verstärktem Nylon gefertigt.

Funktionen

Nur für den Armlehnstuhl mit Fünfarmiges Fußkreuz und den Hocker
– Sitzhöhenverstellung mit Gasdruckfeder.

Sonderzubehörteile

Armlehnstuhl
– Armlehnen: geschlossen, beschichtet und gepolstert.

Hocker

– Fußstütze aus verchromtem Stahl. **(1)**

ES

Materiales

– Estructura en tubular de acero con acolchado de poliuretano autoextinguible espumado en frío.

Tipos

– Butaca.
– Taburete.

Tipos de base

– Base de cuatro patas de madera de haya natural con pies autonivelantes.
– Base piramidal de madera de haya natural, con pies.
– Base de disco de acero revestido de acero inoxidable, giratoria o giratoria con retorno automático.
– Base de cinco radios de aluminio pulido con ruedas o pies. Las ruedas, giratorias y autofrenantes, están fabricadas en nailon para suelos blandos y con banda de poliuretano blando para suelos duros. Los pies fijos son de nailon reforzado.

Mecanismos

Solo para la butaca de cinco radios y para el taburete
– Altura del asiento regulable con pistón a gas.

Accesorios opcionales

Butaca
– Brazos cerrados, tapizados y acolchados.

Taburete

– Reposapiés de acero cromado. **(1)**



EN – Warranty IT – Garanzia
FR – Garantie DE – Garantie
ES – Garantía

Ventuno



Studio Ares



Ventuno

mod. VN05E

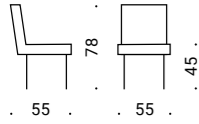
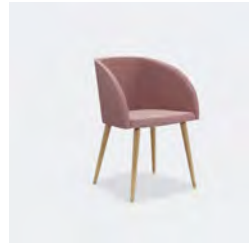

mod. VN05W

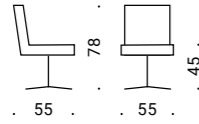
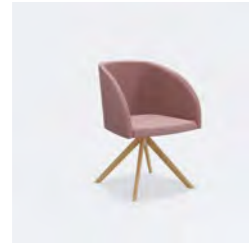

mod. VN05W

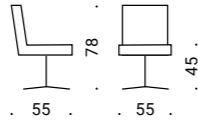

mod. VN05CD

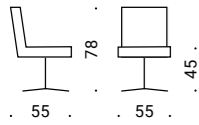
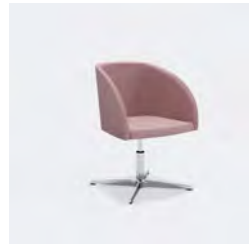

mod. VN05C/Z

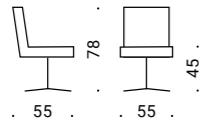
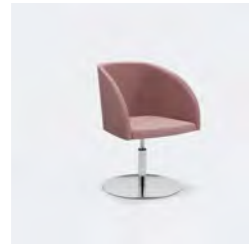

mod. VN05B

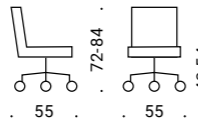
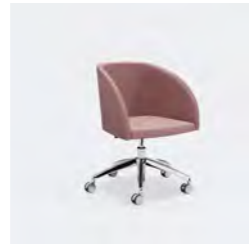

Models







EN

Materials

– Plywood frame.
Padding in self-extinguishing polyurethane foam.

Base types

– Four-leg base in natural beech with self-levelling feet.
– Pyramidal base in natural beech wood, with feet.
– Pyramidal base in varnished steel with feet.
– Steel disk base surfaced with stainless steel, free swivel or automatic return swivel.
– Five-spoke base in polished aluminium with castors or feet. The self-braking swivel castors are in nylon for soft flooring or with soft polyurethane tread for hard flooring. The fixed feet are in reinforced nylon.

Mechanisms

Only on armchair with five-spoke base
– Seat height adjustment with gas cylinder.

IT

Materiali

– Telaio in multistrato. Imbottitura in poliuretano espanso autoestinguento.

Tipologie di base

– Base a quattro gambe in legno di faggio naturale con piedini autolivellanti.
– Base piramidale in legno di faggio naturale, con piedini.
– Base piramidale in acciaio verniciato con piedini.
– Base a quattro razze in alluminio lucidato.
– Base a disco in acciaio rivestito in acciaio inox, girevole o girevole con ritorno automatico in posizione.
– Base a cinque razze in alluminio lucidato con ruote o piedini. Le ruote piroettanti autofrenanti sono in nylon per suolo morbido o con battistrada in poliuretano morbido per suolo duro. I piedini fissi sono in nylon rinforzato.

Meccanismi

Solo nella poltroncina con base a cinque razze
– Regolazione in altezza della seduta con pompa a gas.

FR

Matériaux

– Cadre en bois multiplis.
Rembourrage en polyuréthane expansé autoextinguible.

Types de piètement

– Piètement à quatre jambes en bois de hêtre naturel avec pieds autonivelants.
– Piètement pyramidal en bois de hêtre naturel, avec pieds.
– Piètement pyramidal en acier verni avec pieds.
– Piètement à disque en acier revêtu inox, pivotant ou pivotant avec repositionnement automatique.
– Piètement à cinq branches en aluminium poli avec roulettes ou pieds. Les roulettes pivotantes autofreinantes sont en nylon pour sol souple ou avec chape en polyuréthane souple pour sol dur. Les pieds fixes sont en nylon renforcé.

Mécanismes

Uniquement pour le petit fauteuil avec piètement à cinq branches
– Réglage en hauteur du siège avec vérin à gaz.

DE

Materialien

– Rahmen aus Sperrholz.
Polsterung aus selbstverlöschendem Polyurethanschaum.

Grundmodelle

– Standfuß mit vier Beinen aus naturbelassenem Buchenholz mit selbstausrichtenden Füßen.

– Pyramidenfuß aus lackiertem Stahl, mit Füßen.
– Pyramidenfuß aus naturbelassenem Buchenholz, mit Füßen.
– Vierarmiges Fußkreuz aus poliertem Aluminium.
– Mit Edelstahl beschichteter Stahl-Tellerfuß, drehbar oder drehbar mit automatischer Rückstellfunktion.
– Fünfarmiges Fußkreuz aus poliertem Aluminium mit Rollen oder festen Standfüßen. Die selbstbremsenden Lenkrollen bestehen für weiche Böden aus Nylon. Mit einer weichen Polyurethan-Lauffläche sind sie auch für harte Böden geeignet. Die Standfüße sind aus verstärktem Nylon gefertigt.

Funktionen

Nur für den Armlehnstuhl mit Fünfarmiges Fußkreuz
– Sitzhöhenverstellung mit Gasdruckfeder.

ES

Materiales

– Estructura en multicapa de madera.
Acolchado de poliuretano expandido autoextinguible.

Tipos de base

– Base de cuatro patas de madera de haya natural con pies autonivelantes.
– Base piramidal de madera de haya natural, con pies.
– Base piramidal de acero pintado, con pies.
– Base de disco de acero revestido de acero inoxidable, giratoria o giratoria con retorno automático.
– Base de cinco radios de aluminio pulido con ruedas o pies. Las ruedas, giratorias y autofrenantes, están fabricadas en nailon para suelos blandos y con banda de poliuretano blando para suelos duros. Los pies fijos son de nailon reforzado.

Mecanismos

Solo para la butaca de cinco radio
– Altura del asiento regulable con pistón a gas.



EN – Warranty IT – Garanzia
FR – Garantie DE – Garantie
ES – Garantía

Acoustic

Naxos Acoustic – p. 174

Privée – p. 186

Base – p. 196

Prà – p. 208

Naxos Acoustic



BaccoliniDesign



Naxos Acoustic

mod. 3335R1

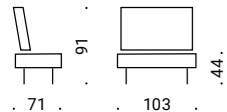

mod. 3335R2

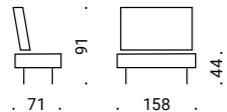

mod. 3315R1

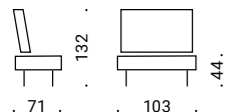

mod. 3315R2

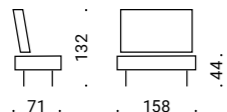

mod. 3331R1

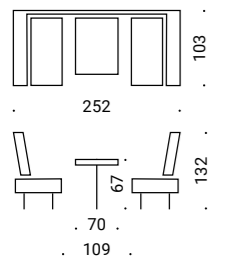

mod. 3331R2

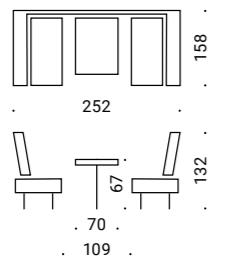

Models



Naxos Acoustic







EN

Materials

— Solid wood structure with particle board support surfaces. Padding in self-extinguishing shape-retaining differential density synthetic foam, upholstered with soft synthetic fibre for increased comfort. Legs in tubular steel coated aluminium grey or chromed.

Types

- 1 seat armchair.
- 1 seat armchair with high back.
- 2 seat sofa.
- 2 seat sofa with high back.

Optional accessories

— Table in particle board, laminated with ABS edging, leg in tubular steel coated aluminium grey or chromed and fixing plate in satin finish stainless steel.
— Upholstered wall panel, suitable for fixing LCD screens of diameters up to 32".

IT

Materiali

— Struttura in legno massello con piani in conglomerato ligneo. Imbottiture in resine espanse indeformabili e autoestinguenti a densità differenziata, ricoperte con morbida fibra di resina che ne aumenta il comfort. Gambe in tubolare d'acciaio verniciato grigio alluminio o cromato.

Tipologie

- Poltrona 1 posto.
- Poltrona 1 posto con schienale alto.
- Divano 2 posti.
- Divano 2 posti con schienale alto.

Accessori opzionali

— Tavolo in agglomerato ligneo, nobilitato con bordo in ABS, gamba in tubolare d'acciaio verniciato grigio alluminio o cromato e piastre di fissaggio in acciaio inox satinato.
— Pannello parete rivestito, idoneo per il fissaggio di schermi LCD di dimensioni massime 32".

FR

Matériaux

— Structure en bois massif avec plans en bois aggloméré. Rembourrages en résines expansées indéformables et autoextinguibles à densité différenciée, recouvertes de fibres de résine souples pour un confort accru. Jambes en tubes d'acier verni gris aluminium ou chromé.

Types

- Fauteuil 1 place.
- Fauteuil 1 place avec dossier haut.

- Canapé 2 places.
- Canapé 2 places avec dossier haut.

Accessoires en option

— Table en bois aggloméré mélaminé avec bords en ABS, jambe en tubes d'acier verni gris aluminium ou chromé et plaques de fixation en acier inox satiné.
— Panneau mural revêtu, approprié pour le fixage d'écrans LCD d'une dimension maximale de 32".

DE

Materialien

— Massivholzstruktur mit Platten aus Schichtholz. Polsterung aus formstabilem, selbstverlöschendem, Kunstharzschaum unterschiedlicher Dichte, überzogen mit weichen Kunstharzfasern zur Steigerung des Komforts. Beine aus aluminiumgrau lackiertem oder verchromtem Stahlrohr.

Typen

- Einsitzer-Bank.
- Einsitzer-Bank mit hoher Rückenlehne.
- Zweisitzer-Sofa.
- Zweisitzer-Sofa mit hoher Rückenlehne.

Sonderzubehörteile

— Tisch aus Schichtholz, veredelt mit ABS-Kante, Fuß aus aluminiumgrau lackiertem Stahlrohr oder verchromt und Befestigungsplatten aus satiniertem Edelstahl.
— Beschichtetes Wandpaneel, geeignet für die Befestigung von LCD-Bildschirmen bis zu einer Größe von 32 Zoll.

ES

Materiales

— Estructura de madera maciza con tableros de aglomerado. Acolchados de resinas expandidas indeformables y autoextinguibles de diferentes densidades, recubiertas de fibra de resina blanda para aumentar el confort. Patas en tubular de acero pintado en gris aluminio o cromado.

Tipos

- Sillón 1 plaza.
- Sillón 1 plaza con respaldo alto.
- Sofá 2 plazas.
- Sofá de 2 plazas con respaldo alto.

Accesorios opcionales

— Mesita de aglomerado de madera, revestida con borde perimetral de ABS, pata en tubular de acero pintado en gris aluminio o cromado y placas de fijación de acero inoxidable satinado.
— Panel de pared revestido, adecuado para fijar pantallas LCD de hasta 32" de tamaño.

EN

Acoustic research

Using the sound intensity method

Results

Total acoustic comfort and the clearest and cleanest intelligibility of speech during conversation ranging in volume from 10-15 db and in frequencies between 500-2,000 Hz. Frequency interval 100 Hz—3.15 kHz. Chromatic scale of acoustic intensity 100-70 decibel (dB).

IT

Indagine acustica

Effettuata con metodo intensimetrico

Risultato

Totale benessere acustico per una più pulita e chiara intelligibilità del parlato durante una conversazione, con abbattimento di 10-15 db per frequenze del parlato tra i 500 Hz e i 2000 Hz. Intervallo di frequenza 100 Hz—3.15 kHz. Scala cromatica di intensità acustica da 100-70 decibel (dB).

FR

Test acoustique

Réalisé en utilisant la méthode de l'intensité sonore

Résultat

Confort acoustique total pour une plus claire et distincte intelligibilité de la parole au cours des conversations dans un volume compris entre 10 et 15 db et dans des fréquences vocales entre 500 et 2 000 Hz. Intervalle de fréquence entre 100 Hz et 3,15 kHz. Échelle chromatique de l'intensité acoustique 100-70 décibels (dB).

DE

Akustische Vermessung

Durchgeführt mit intensimetrischem Verfahren

Ergebnis

Vollkommenes akustisches Wohlbefinden für sauberste und klarste Sprachverständlichkeit während eines Gesprächs, mit einer Reduzierung von 10-15 dB für Sprachfrequenzen zwischen 500 Hz und 2000 Hz. Frequenzbereich 100 Hz—3,15 kHz, Farbskala der Schallintensität 100-70 decibel (dB).

ES

Estudio acústico

Realizado con intensimetría acústica

Resultado

Bienestar acústico total para una inteligibilidad más limpia y clara durante una conversación, con una reducción de entre 10-15 dB para frecuencias de conversación de entre 500 Hz y 2000 Hz. Intervalo de frecuencia 100 Hz—3.15 kHz. Escala cromática de intensidad acústica 100-70 decibel (dB).

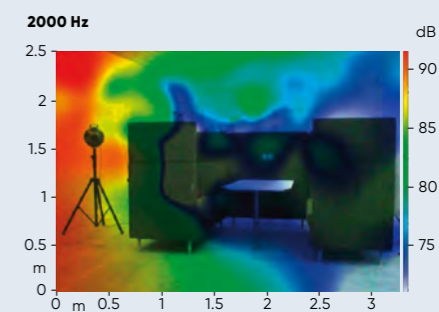
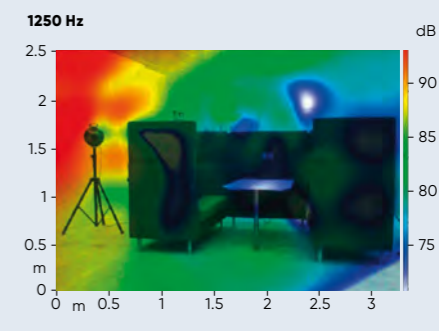
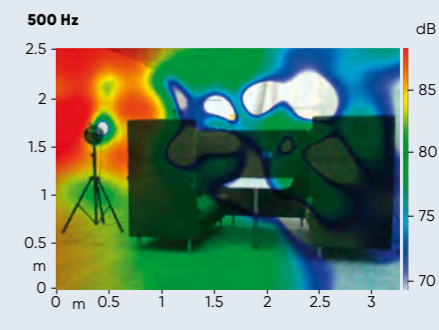

EN — Warranty IT — Garanzia
FR — Garantie DE — Garantie
ES — Garantía

Privée

Progetto CMR

Privée



mod. 390AR1

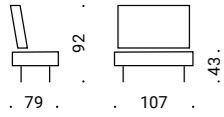

mod. 390AR2

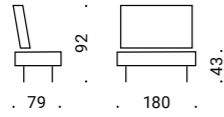

mod. 390CR1

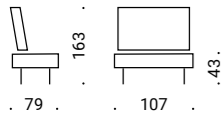

mod. 390CR2

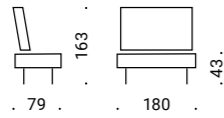

mod. 3992

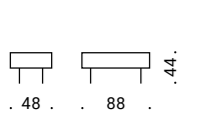

mod. 399P

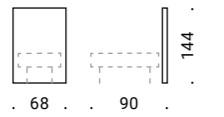

Models

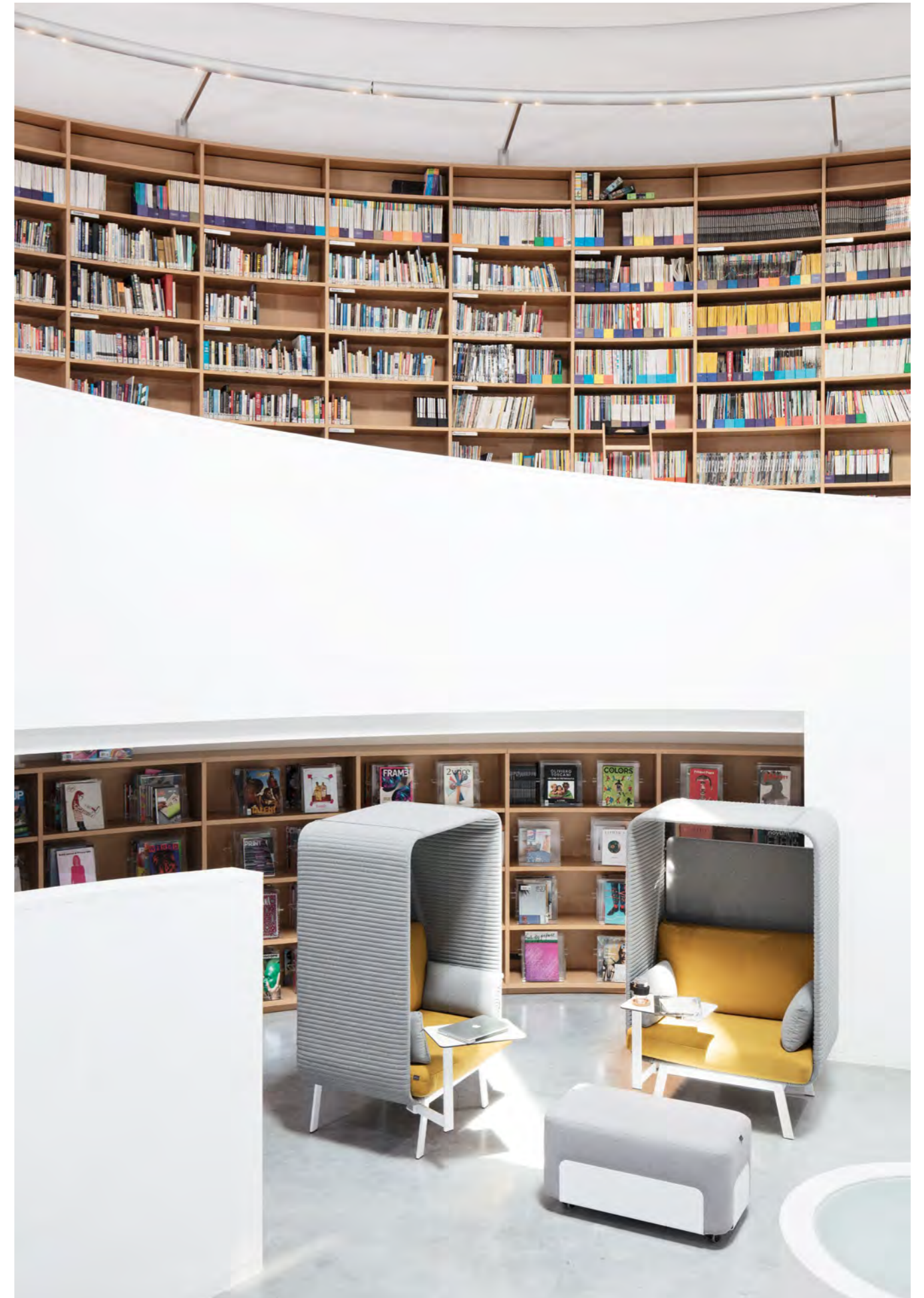

Privée



EN

Materials*Armchair and sofa*

– Frame and legs in rectangular steel section with feet in polyethylene. Internal perimeter frame for sides and canopy in steel tube and plate with upholstery in ribbed fabric. Seat, backrest, armrest, and external frame padded in self-extinguishing differential density polyurethane foam. Internal frame padding in recycled polyurethane agglomerate. Seat and backrest inserts in birch plywood.

Pouf

– Base frame in steel plate with particle board insert. Padding in self-extinguishing polyurethane foam upholstered with fabric. Self-braking castors in reinforced nylon.

Types

- 1 seat armchair.
- 1 seat armchair with canopy.
- 2 seat sofa.
- 2 seat sofa with canopy.
- Pouf.

Optional accessories*Armchair and sofa*

– Padded removable headrest in steel rod upholstered with ribbed fabric. **(2–3)**

– LED lighting system equipped with proximity sensor with power supply unit, USB recharge and mains connection cable with Italian plug. **(1)**

– Rotating writing tablet in HPL with tubular steel support.

Pouf

– Rotating writing tablet in HPL with tubular steel support.

– Sound insulation dividing panel in beech plywood upholstered in fabric.

IT

Materiali*Poltrona e divano*

– Struttura del telaio e gambe in tubo rettangolare d'acciaio con piedini in polietilene. Struttura perimetrale interna dei fianchi e del canopy in tubo e lamiera d'acciaio con rivestimento in tessuto cannettato. Imbottiture di sedile, schienale, braccioli e struttura esterna in poliuretano espanso autoestinguente con densità differenziate. Imbottitura della struttura interna in agglomerato di poliuretano riciclato. Inserto di sedile e schienale in multistrato di betulla.

Pouf

– Struttura del fondo in lamiera d'acciaio con inserto in truciolare. Imbottitura in poliuretano espanso

autoestinguente rivestito in tessuto. Ruote autofrenanti in nylon caricato.

Tipologie

- Poltrona 1 posto.
- Poltrona 1 posto con canopy.
- Divano 2 posti.
- Divano 2 posti con canopy.
- Pouf.

Accessori opzionali*Poltrona e divano*

– Poggiatesta imbottito rimovibile in tondino d'acciaio rivestito in tessuto cannettato. **(2–3)**

– Sistema di illuminazione a LED dotato di sensore di prossimità con alimentatore, ricarica USB e cavo di allacciamento alla rete con presa italiana. **(1)**

– Tavolino scrittoio ruotabile in HPL con supporto in tubolare d'acciaio.

Pouf

– Tavolino scrittoio ruotabile in HPL con supporto in tubolare d'acciaio.

– Pannello divisorio fonoassorbente in multistrato di faggio rivestito in tessuto.

FR

Matériaux*Fauteuil et canapé*

– Structure du cadre et jambes en tubes d'acier à section rectangulaire avec pieds en polyéthylène. Structure du périmètre interne des flancs et du baldaquin en tubes et tôle d'acier avec revêtement en tissu canisse. Rembourrage de l'assise, du dossier, des accoudoirs et structure externe en polyuréthane expansé autoextinguible à densité différenciée. Rembourrage de la structure interne en aggloméré de polyuréthane recyclé. Insert de l'assise et dossier en bois de bouleau multiplis.

Pouf

– Structure de la base en tôle d'acier avec insert en aggloméré. Rembourrage en polyuréthane expansé autoextinguible revêtu de tissu. Roulettes autofreinantes en nylon renforcé.

Types

- Fauteuil 1 place.
- Fauteuil 1 place avec baldaquin.
- Canapé 2 places.
- Canapé 2 places avec baldaquin.
- Pouf.

Accessoires en option*Fauteuil et canapé*

– Appuie-tête rembourré amovible en tubes d'acier à section circulaire revêtu de tissu canisse. **(2–3)**

– Système d'éclairage à LED équipé d'un détecteur de présence avec alimentation, recharge USB et câble de

branchement au réseau avec prise italienne. **(1)**

– Tablette écriteiro pivotante en HPL avec support en tubes d'acier.

Pouf

– Tablette écriteiro pivotante en HPL avec support en tubes d'acier.

– Cloison phono-absorbante en bois de hêtre multiplis revêtu de tissu.

DE

Materialien*Sessel und Sofa*

– Rahmenkonstruktion und Beine aus Vierkantstahlrohr mit Polyethylenfüßen. Innenliegende Außenumrandung der Seiten und des Baldachins aus Rohr und Stahlblech mit einem dauerhaften Stoffbezug. Sitz, Rückenlehne, Armlehnen und Außengestell mit selbstverlöschendem Polyurethanschaum in verschiedenen Dichten gepolstert. Innenliegende Gewebepolsterung aus recyceltem Polyurethanschaumstoff. Sitz- und Rückenlehneinsatz aus Birkenperrholz.

Pouf

– Sockelkonstruktion aus Stahlblech mit Spanplatteneinsatz. Polsterung aus selbstverlöschendem Polyurethanschaum mit Stoffbezug. Selbstbremsende Räder aus verstärktem Nylon.

Typen

- Einsitzer-Bank.
- Einsitzer-Bank mit Baldachin.
- Zweisitzer-Sofa.
- Zweisitzer-Sofa mit Baldachin.
- Pouf.

Sonderzubehörteile*Sessel und Sofa*

– Abnehmbare, gepolsterte Kopfstütze aus Stahlrohr, überzogen mit dauerhaftem Stoff. **(2–3)**

– LED-Beleuchtungssystem mit Abstandssensor mit Netzteil, USB-Ladegerät und Netzkabel mit italienischem Stecker. **(1)**

– Drehbarer HPL-Schreibtisch mit Stahlrohrstütze.

Pouf

– Drehbarer HPL-Schreibtisch mit Stahlrohrstütze.

– Schalldämmende Trennwand aus Buchensperrholz mit Stoffbezug.

ES

Materiales*Sillón y sofá*

– Estructura y patas en tubular de acero rectangular con pies de polietileno. Estructura perimetral interior de los laterales y del dosel en tubo y chapa de acero tapizados con tela canneté. Acolchado del asiento, del respaldo, de los brazos y de la estructura externa en espuma de poliuretano expandido autoextinguible de diferentes densidades. Acolchado de estructura interna en aglomerado de poliuretano reciclado. Asiento y respaldo con elemento en multicapa de abedul.

Puf

– Estructura de la base en chapa de acero con inserción de aglomerado. Acolchado de poliuretano expandido autoextinguible tapizado con tela. Ruedas autofrenantes de nailon reforzado.

Tipos

- Sillón 1 plaza.
- Sillón 1 plaza con dosel.
- Sofá 2 plazas.
- Sofá 2 plazas con dosel.
- Puf.

Accesorios opcionales*Sillón y sofá*

– Reposacabezas acolchado desmontable de varillas de acero tapizado con tela canneté. **(2–3)**

– Sistema de iluminación LED equipado con sensor de proximidad con alimentador, recarga USB y cable de red con enchufe italiano. **(1)**

– Mesita giratoria en HPL con soporte en tubular de acero.

Puf

– Mesita giratoria en HPL con soporte en tubular de acero.

– Panel divisorio insonorizante en multicapa de haya tapizado en tela.

1



EN

Scientifically tested acoustic comfort

60% of the sound waves reflected in highly reverberant environments come from the ceiling. This is why Privée features not only a high back and sides, but also a canopy to enhance its performance.

Results

Total acoustic comfort and the clearest and cleanest intelligibility of speech during conversation at a volume over 15db and in frequencies between 500-2,000 Hz. Frequency interval 100 Hz – 3.15 kHz. Chromatic scale of acoustic intensity 80-50 decibel (dB).

IT

Comfort acustico scientificamente testato

Il 60% delle onde riflesse in un ambiente con forte riverbero arriva dal soffitto. Per questo Privée è dotato di schienale e fianchi alti, ma anche di un canopy per una migliore performance.

Risultato

Totale benessere acustico per una più pulita e chiara intelligibilità del parlato durante una conversazione, con abbattimento di oltre 15 db per frequenze del parlato tra i 500 Hz e i 2000 Hz. Intervallo di frequenza 100 Hz – 3.15 kHz. Scala cromatica di intensità acustica 80-50 decibel (dB).

FR

Confort acoustique testé scientifiquement

60 % des ondes réfléchies dans une pièce avec une forte réverbération arrivent du plafond. Pour cette raison, Privée est équipé d'un dossier et de côtés hauts, mais surtout d'un « plafond » qui augmente ses performances.

Résultat

Bien-être acoustique total pour une intelligibilité de la parole plus claire et distincte lors d'une conversation avec abaissement phonique supérieur à 15 db pour des fréquences vocales entre 500 et 2 000 Hz. Intervalle de fréquence entre 100 Hz et 3,15 kHz. Échelle chromatique d'intensité acoustique 80-50 décibels (dB).

DE

Wissenschaftlich nachgewiesener akustischer Komfort

60 % der in einem stark nachhallenden Raum reflektierten Schallwellen kommen von der Decke. Aus diesem Grund wurde Privée mit hohen Rücken- und Seitenteilen sowie einem Baldachin ausgestattet, um eine bessere Schalldämmleistung zu erreichen.

Ergebnis

Vollkommenes akustisches Wohlbefinden für sauberste und klarste Sprachverständlichkeit während eines Gesprächs, mit einer Reduzierung von mehr als 15 dB bei Sprachfrequenzen zwischen 500 Hz und 2000 Hz. Frequenzbereich 100 Hz – 3,15 kHz, Farbskala der Schallintensität 80-50 decibel (dB).

ES

Confort acústico científicamente testado

El 60 % de las ondas reflejadas en un entorno con fuerte reverberación llega desde el techo. Por este motivo, Privée incorpora respaldo y laterales altos, pero sobre todo un dosel que mejora su rendimiento.

Resultado

Bienestar acústico total para una inteligibilidad más limpia y clara durante una conversación, con una reducción de más de 15 dB para frecuencias de conversación de entre 500 Hz y 2000 Hz. Intervalo de frecuencia 100 Hz – 3.15 kHz. Escala cromática de intensidad acústica 80-50 decibel (dB).

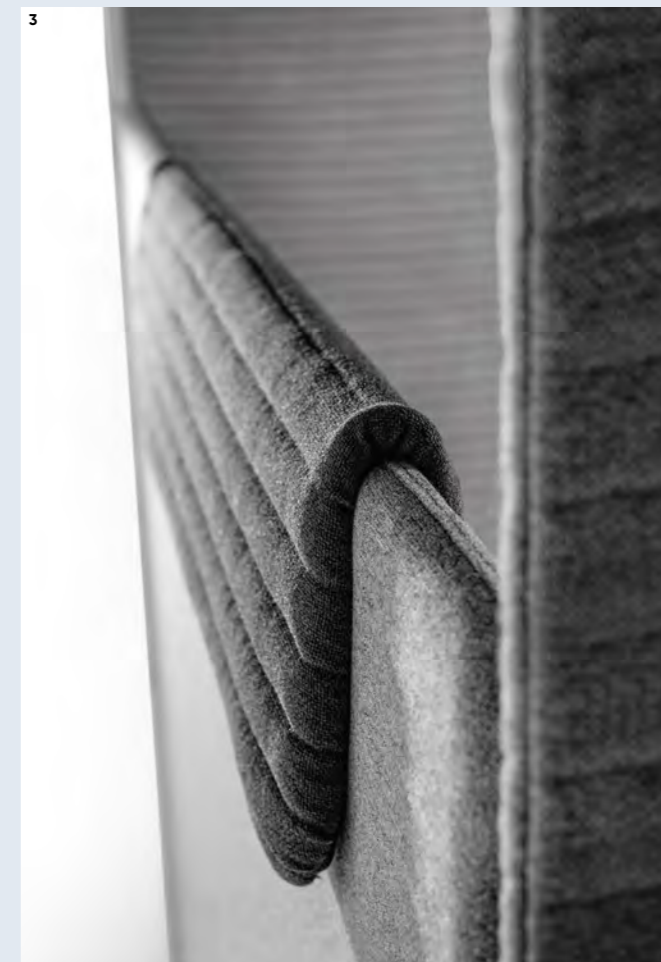
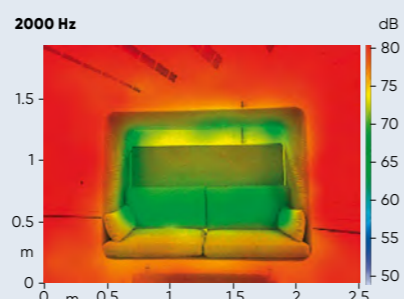
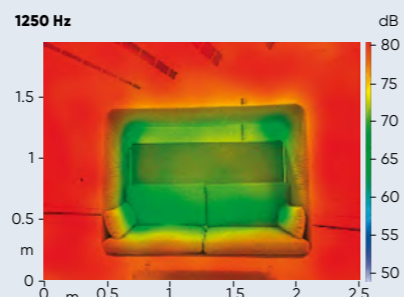
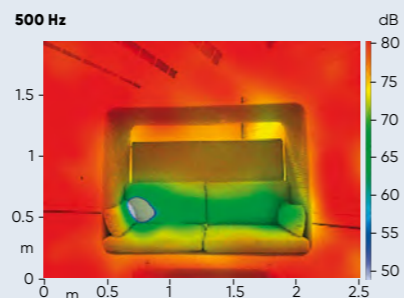

EN – Warranty IT – Garanzia
FR – Garantie DE – Garantie
ES – Garantía

Base



mod. PRT

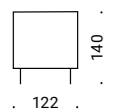

mod. SPR

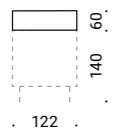

mod. DV1

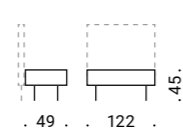
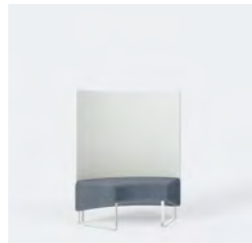

mod. TTC

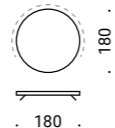

mod. DV3

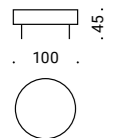

mod. DV4

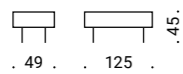

mod. DV5

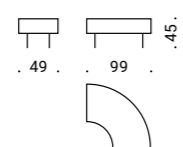

mod. DV6

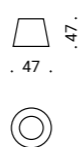

mod. BA90

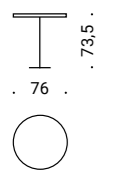

Models



Base

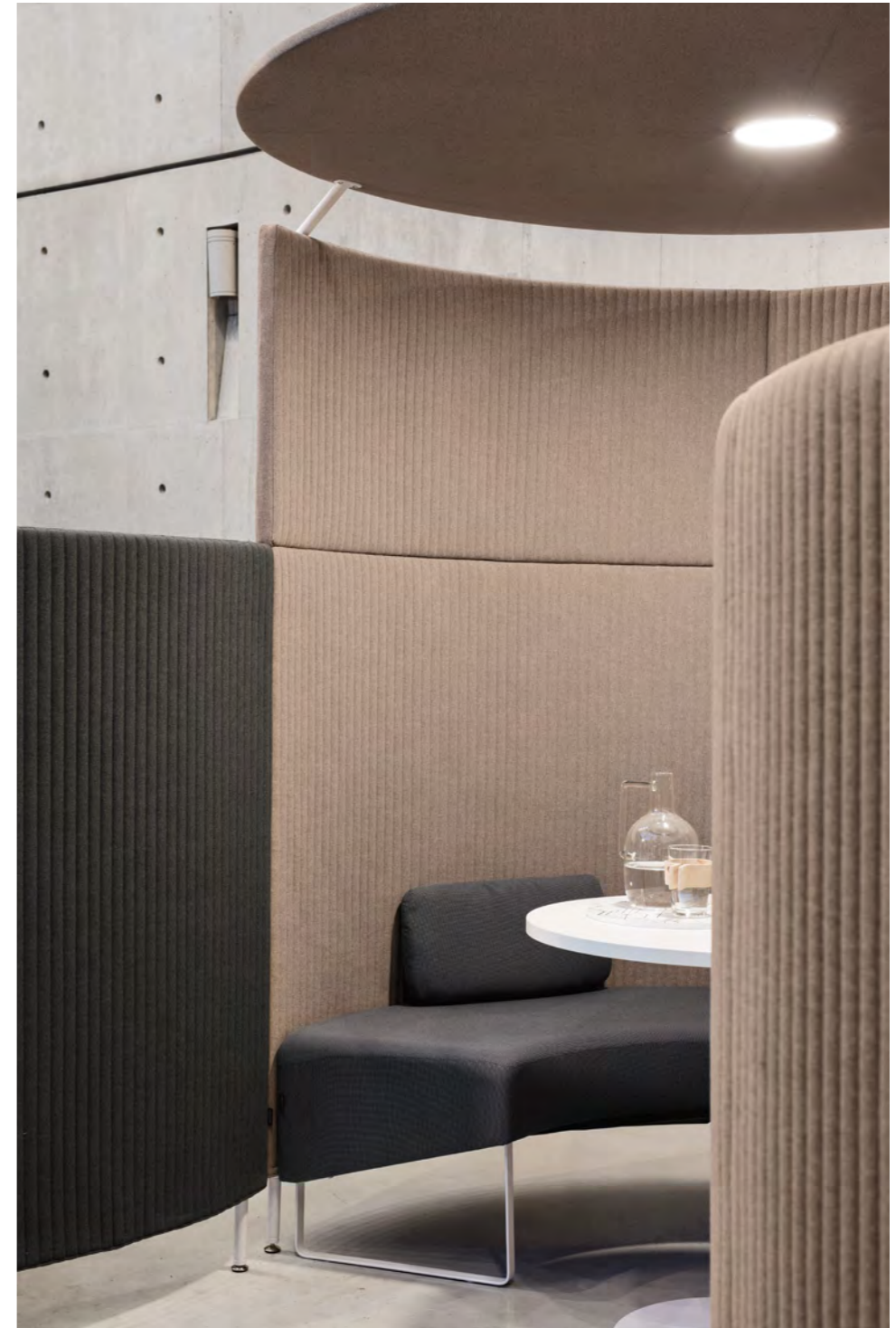



EN

Materials*Modular curved wall**with curved wall extension*

– Wood plywood frame and vegetable fibre panels upholstered with ribbed Trevira fabric. Height adjustable support feet in chromed steel fitted on a coated tubular frame.

Sofas

– Plywood frame and particle board panels with vegetable fibre panel infill. Padding in self-extinguishing polyurethane foam. Support structure in perforated steel plate with rounded edging, fitted with anti-slip felt pads. The wall version is fixed by steel bayonet attachment.

Types

- Modular curved wall.
- Curved wall extension.
- Curved sofa for wall.
- Curved sofa.
- Circular sofa.
- Rectangular sofa.

Optional accessories

- Circular roof in particle board with Trevira fabric upholstery, wall fixture with coated steel supports.
- Pouf in wood plywood with vegetable fibre panel infill and padding in self-extinguishing polyurethane foam. Base with five swivel castors and self-braking system.
- Side table with circular support surface in white laminated particle board with matching edging in ABS. Metal frame with coated circular steel foot.

Only curved wall divan

– Lumbar support cushion in self-extinguishing polyurethane.

IT

Materiali*Parete curva aggregabile**e sopralzo curvo per parete*

– Struttura in multistrato di legno e pannelli di fibra vegetale con rivestimento in tessuto Trevira cannettato. Piedini d'appoggio regolabili in altezza in acciaio cromato montati su struttura in tubolare verniciato.

Divanetti

– Telaio in multistrato e pannelli di particelle di legno con tamponature in pannello di fibra vegetale. Imbottitura in poliuretano espanso autoestinguento. Struttura d'appoggio in piatto trafilato d'acciaio con bordi arrotondati, equipaggiata con feltrini antiscivolo. La versione per parete si fissa con aggancio in acciaio a baionetta.

Tipologie

- Parete curva aggregabile.
- Sopralzo curvo per parete.
- Divanetto curvo per parete.
- Divanetto curvo.
- Divanetto circolare.
- Divanetto rettangolare.

Accessori opzionali

– Tetto circolare in conglomerato ligneo con rivestimento in tessuto Trevira, fissato alle pareti con supporti in acciaio verniciati.

– Pouf in legno multistrato con tamponature realizzate in pannello di fibra vegetale e imbottitura in poliuretano espanso autoestinguento.

Base a cinque ruote piroettanti con sistema frenante automatico.

– Tavolino con piano circolare in pannello di particelle di legno placcato in laminato bianco con bordo in ABS in tinta. Struttura metallica con piede circolare in acciaio verniciato.

Solo divanetto curvo per parete

– Cuscino di supporto lombare in poliuretano autoestinguento.

FR

Matériaux*Cloison courbe incorporable et couronnement courbe pour mur*

– Structure en bois multiplis et panneaux en fibre végétale avec revêtement en tissu canisse Trevira.

Pieds d'appui réglables en hauteur en acier chromé montés sur structure en tubes d'acier verni.

Petits canapés

– Cadre en bois multiplis et panneaux en particules de bois avec remplissages réalisés en panneau de fibre végétale.

Rembourrage en polyuréthane expansé autoextinguible. Structure d'appui en plat d'acier étiré avec bords arrondis, équipée de feutres antidérapants.

La version murale se fixe avec une fixation en acier à baïonnette.

Types

- Cloison courbe incorporable.
- Couronnement courbe pour mur.
- Petit canapé courbe pour mur.
- Petit canapé courbe.
- Petit canapé rond.
- Petit canapé rectangulaire.

Accessoires en option

– Couverture circulaire en bois aggloméré avec revêtement en tissu Trevira, fixée au mur avec des supports en acier verni.

– Pouf en bois multiplis avec remplissages réalisés en panneau de fibre végétale et rembourrage en polyuréthane expansé autoextinguible.

Piètement à cinq roulettes pivotantes

avec système de freinage automatique.

– Table basse à plateau rond en mélaminé blanc avec bord en ABS du même ton. Structure métallique avec pied rond en acier verni.

*Uniquement petit**canapé courbe pour mur*

– Coussin de soutien lombaire en polyuréthane autoextinguible.

DE

Materialien*Gebogene, kombinierbare Wand**und gebogener Wandaufsatz*

– Gestell aus Sperrholz- und Pflanzenfaserplatten mit einem Überzug aus durablem Trevira-Stoff. Höhenverstellbare Stützfüße aus verchromtem Stahl, die auf einer lackierten Rohrkonstruktion montiert sind.

Kleine Sofas

– Rahmen aus Sperrholz und Holzfasern mit einer Wattierung aus Pflanzenfasern.

Polsterung aus selbstverlöschendem Polyurethanschaum. Weiße Trägerkonstruktion aus gezogener Stahlplatte mit abgerundeten Kanten, ausgestattet mit rutschfestem Filz. Die Wandausführung wird mit einem Bajonettstahlhaken befestigt.

Typen

- Kombinierbare, gebogene Wand.
- Gebogener Wandaufsatz.
- Gebogenes Wandsofa.
- Kleines, gebogenes Sofa.
- Kleines, rundes Sofa.
- Kleines, rechteckiges Sofa.

Sonderzubehörteile

– Runddach aus Schichtholz mit Trevira-Gewebeabdeckung, Befestigung an den Wänden mit lackierten Stahlstützen.

– Pouf aus Sperrholz mit einer Wattierung aus Pflanzenfaserfüllung und einer Polsterung aus selbstverlöschendem Polyurethanschaum. Sockel mit fünf selbstbremsenden Lenkrollen.

– Couchtisch mit runder Platte aus weißer Laminatspanplatte mit passender ABS-Kante. Metallkonstruktion mit rundem Fuß aus lackiertem Stahl.

Nur gebogenes Wandsofa

– Lordosenstützkissen aus selbstverlöschendem Polyurethan.

ES

Materiales*Pared curva opcional**y soporte curvo para la pared*

– Estructura en multicapa de madera y paneles de fibra vegetal tapizados con tela Trevira canneté. Pies de apoyo de altura regulable en acero cromado montados sobre una estructura en tubular pintada.

Sofás

– Estructura en multicapa de madera y paneles de partículas de madera con remates realizados en panel de fibra vegetal. Acolchado de poliuretano expandido autoextinguible. Estructura de apoyo de chapa de acero trefilado con bordes redondeados, dotada de fieltros antideslizantes. La versión de pared se fija con un enganche de bayoneta de acero.

Tipos

- Pared curva opcional.
- Soporte curvo para pared.
- Sofá curvo para pared.
- Sofá curvo.
- Sofá circular.
- Sofá rectangular.

Accesorios opcionales

– Cubierta circular de aglomerado de madera tapizada con tela Trevira, fijada a las paredes con soportes de acero pintados.

– Puf en multicapa de madera con remates realizados en panel de fibra vegetal y acolchado de poliuretano expandido autoextinguible.

Base de cinco ruedas giratorias con sistema de frenado automático.

– Mesita pequeña con tablero circular en panel de partículas de madera chapada en laminado blanco con borde ABS a juego. Estructura metálica con pie circular de acero pintado.

Solo sofá curvo para pared

– Cojín de soporte lumbar de poliuretano autoextinguible.

EN – Arrangement types

IT – Tipologie di composizione

FR – Types de composition

DE – Arten der Zusammenstellung

ES – Tipos de composición

BS01

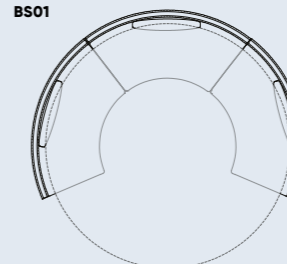

BS02

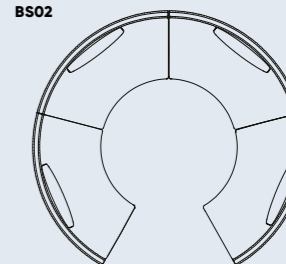

BS03

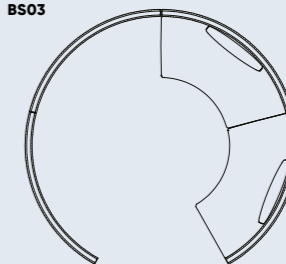

BS05

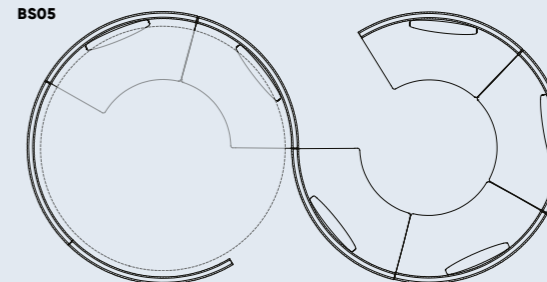

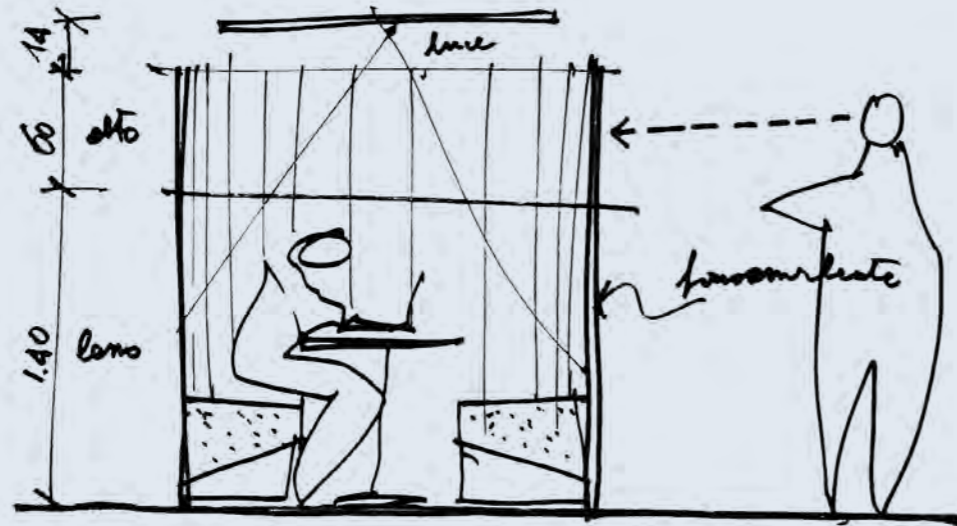
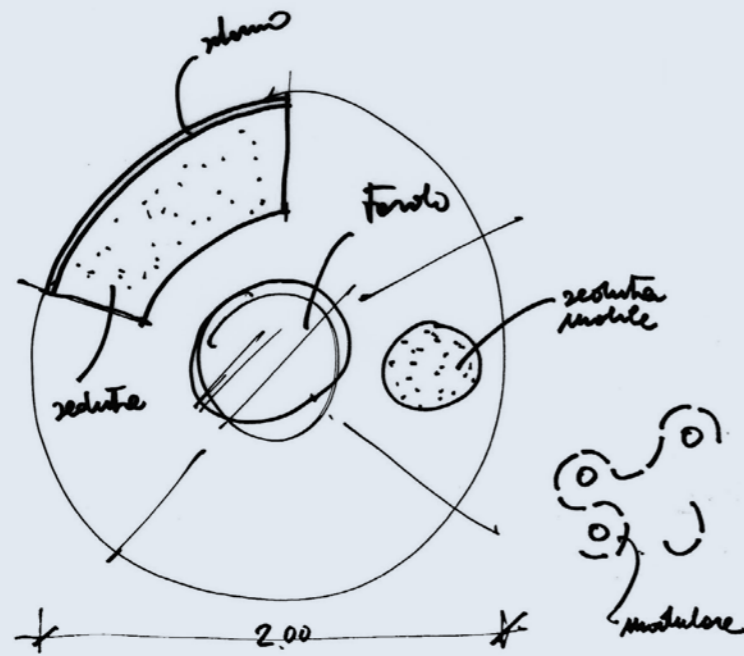

EN
Acoustic research using the sound intensity method

Results
Total acoustic comfort and the clearest and cleanest intelligibility of speech during conversation ranging in volume from 10-15db and in frequencies between 500-2,000 Hz. Frequency interval 100 Hz – 3.15 kHz. Chromatic scale of acoustic intensity 95-75 decibel (dB).

IT
Indagine acustica effettuata con metodo intensimetrico

Risultato
Totale benessere acustico per una pulita e chiara intelligibilità del parlato durante una conversazione, con abbattimento di 10-15 db per frequenze del parlato tra i 500 Hz e i 2000 Hz. Intervallo di frequenza 100 Hz – 3.15 kHz. Scala cromatica di intensità acustica 95-75 decibel (dB).

FR
Test acoustique réalisé avec la méthode de l'intensité sonore

Résultat
Confort acoustique total pour une plus claire et distincte intelligibilité de la parole au cours des conversations dans un volume compris entre 10 et 15 db et dans des fréquences vocales entre 500 et 2 000 Hz. Intervalle de fréquence entre 100 Hz et 3,15 kHz. Échelle chromatique de l'intensité acoustique 95-75 décibels (dB).

DE
Akustische Vermessung mit intensimetrischem Verfahren

Ergebnis
Vollkommenes akustisches Wohlbefinden für sauberste und klarste Sprachverständlichkeit während eines Gesprächs, mit einer Reduzierung von 10-15 dB für Sprachfrequenzen zwischen 500 Hz und 2000 Hz. Frequenzbereich 100 Hz – 3,15 kHz, Farbskala der Schallintensität 95-75 decibel (dB).

ES
Estudio acústico realizado con intensimetría acústica

Resultado
Bienestar acústico total para una inteligibilidad más limpia y clara durante una conversación, con una reducción de entre 10-15 dB para frecuencias de conversación de entre 500 Hz y 2000 Hz. Intervalo de frecuencia 100 Hz – 3.15 kHz. Escala cromática de intensidad acústica 95-75 decibel (dB).

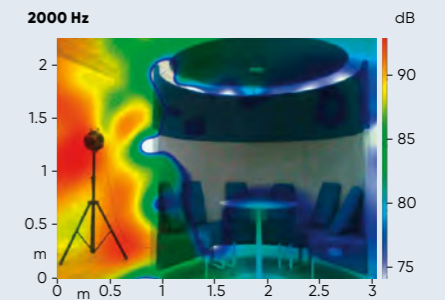
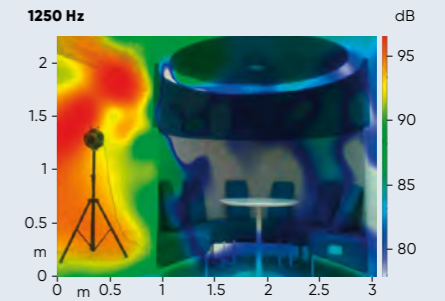
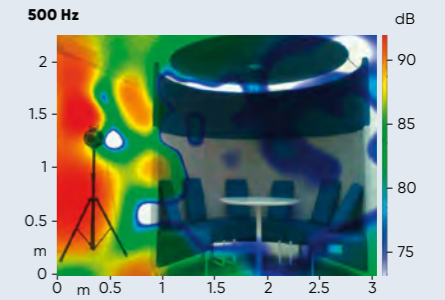

EN – Warranty IT – Garanzia
FR – Garantie DE – Garantie
ES – Garantía

Prà

Sandro Rai



Prà

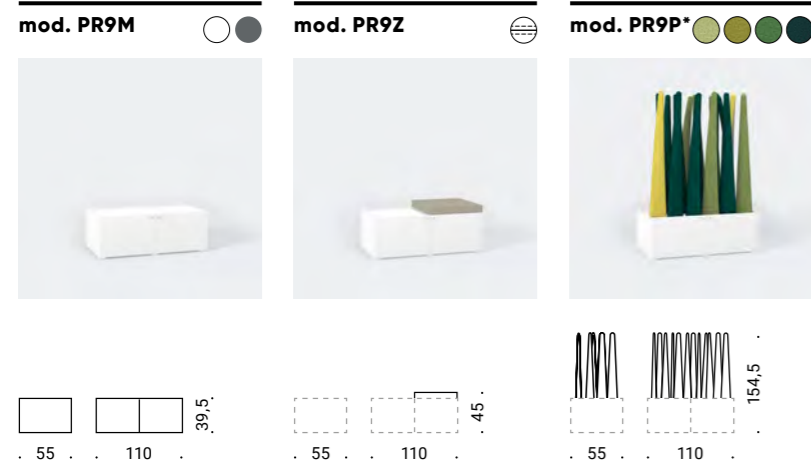

Models



Prà

- EN — Upholstered
- IT — Tapezzato
- FR — Tapissée
- DE — Stoffbezogen
- ES — Tapizada

- * EN — Code referring to an acoustic element
- IT — Codice riferito a un elemento acustico
- FR — Code indiquant un élément acoustique
- DE — Der Code bezieht sich auf ein akustisches Element
- ES — Código referido a un elemento acústico

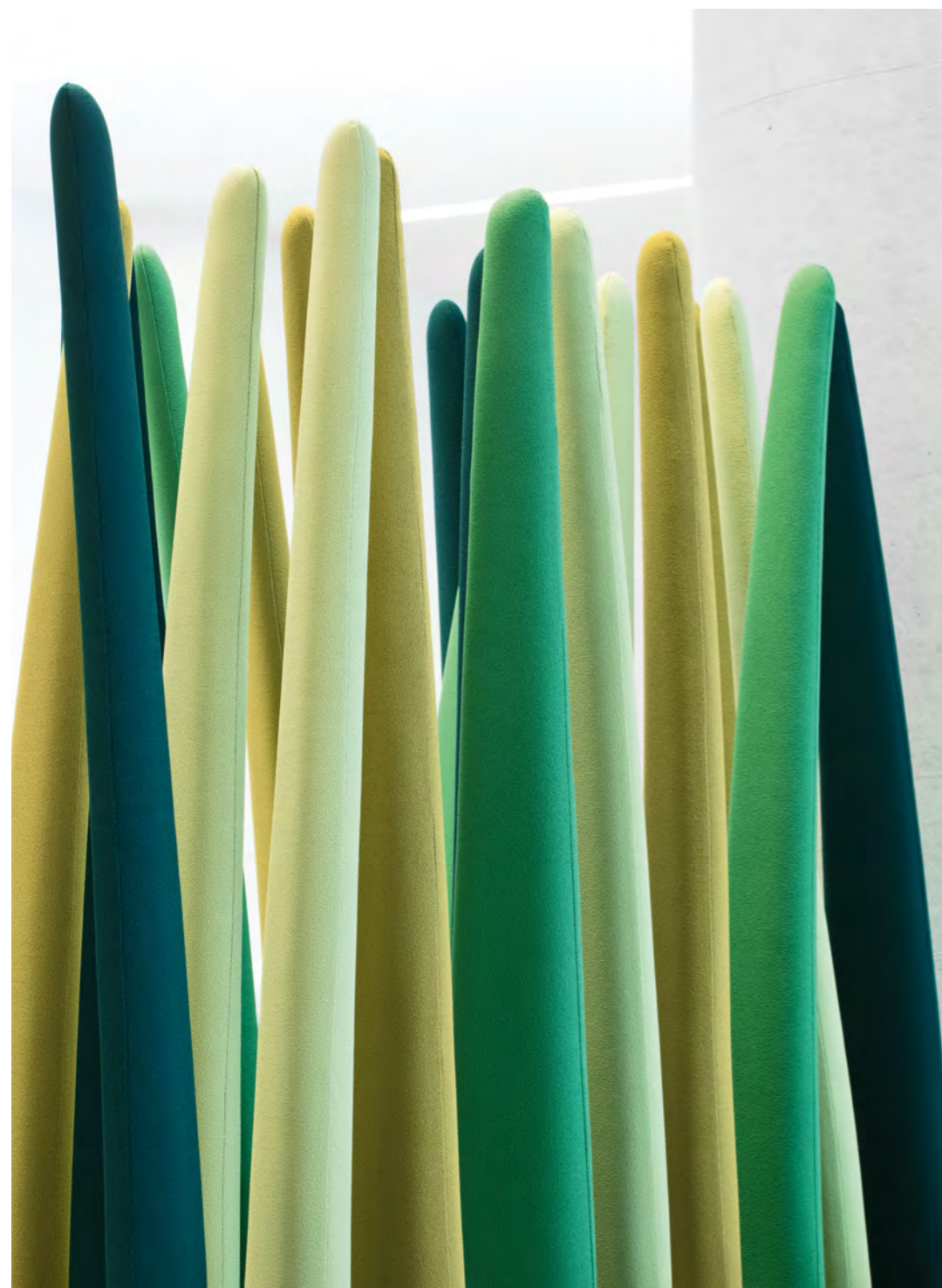

EN
Acoustic research using
the sound intensity method

Results
Average reduction of more than 33% in reverberation time on voice frequencies between 500-2000 Hz. Frequency interval 100 Hz–3.15 kHz. Chromatic scale of acoustic intensity 85-81 decibel (dB).

FR
Test acoustique réalisé avec
la méthode de l'intensité sonore

Résultat
Réduction moyenne supérieure à 33 % du temps de réverbération pour des fréquences vocales comprises entre 500 et 2 000 Hz. Intervalle de fréquence entre 100 Hz et 3,15 kHz. Échelle chromatique de l'intensité acoustique 85-81 décibels (dB).

ES
Estudio acústico realizado
con intensimetría acústica

Resultado
Reducción media superior del 33% del tiempo de reverberación en las frecuencias de conversación de entre 500 Hz y 2000 Hz. Intervalo de frecuencia 100 Hz–3.15 kHz. Escala cromática de intensidad acústica 85-81 decibel (dB).

IT
Indagine acustica effettuata
con metodo intensimetrico

Risultato
Riduzione media superiore del 33% del tempo di riverbero sulle frequenze del parlato tra i 500 Hz e i 2000 Hz. Intervallo di frequenza 100 Hz–3.15 kHz. Scala cromatica di intensità acustica 85-81 decibel (dB).

DE
Akustische Vermessung mit
intensimetrischem Verfahren

Ergebnis
Reduzierung der Nachhallzeit bei Sprachfrequenzen zwischen 500 Hz und 2000 Hz um durchschnittlich 33 %. Frequenzbereich 100 Hz–3,15 kHz, Farbskala der Schallintensität 85-81 decibel (dB).

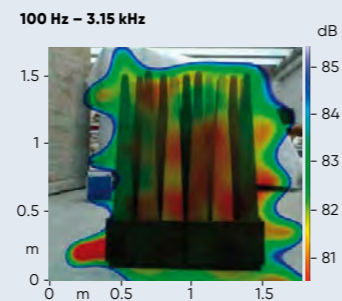

EN
Comparison between reverberation
time in reverberating chamber
(7.70x5.60x3.70 m)
with and without Prà.

FR
Comparaison du temps de
réverbération dans la chambre à
réverbération (7,70 x 5,60 x 3,70 m)
avec et sans Prà.

ES
Comparación del tiempo de
reverberación en la cámara
reverberante (7,70 x 5,60 x 3,70 m)
con y sin Prà.

IT
Confronto del tempo di riverbero nella
camera riverberante (7,70x5,60x3,70 m)
con e senza Prà.

DE
Vergleich der Nachhallzeit
im Hallraum (7,70x5,60x3,70 m)
mit und ohne Prà.

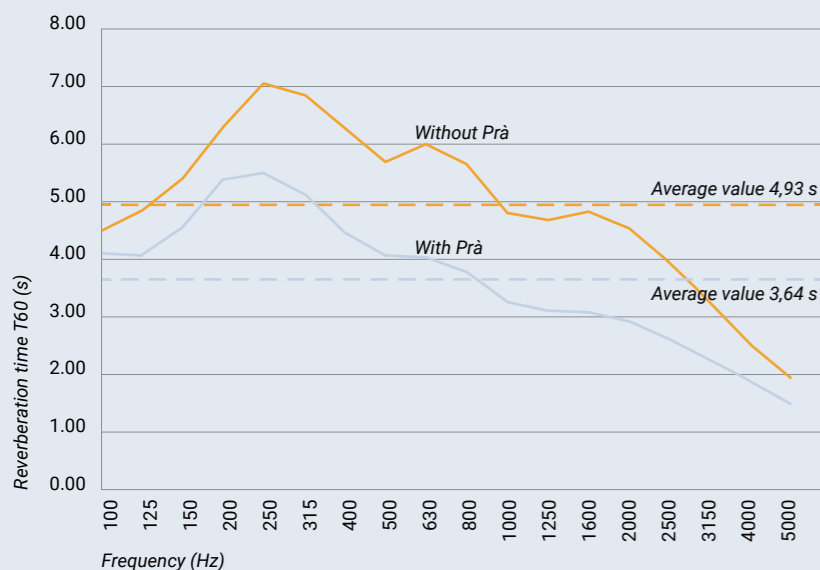

EN
Materials
Unit

– Double swing door unit in plastic plywood edged with ABS. Inset handle and feet in plastic material.

Sound insulation barrier
– Substructure in galvanized shaped steel plate and padding in self-extinguishing polyurethane foam with Mirage fabric upholstery.

Cushion
– Base in milled wood and padding in self-extinguishing polyurethane foam with Trevira fabric upholstery.

IT
Materiali
Mobile
– Struttura a due ante battenti in nobilitato plastico bordato in ABS. Maniglia a incasso e piedini in materiale plastico.

Elemento fonoassorbente
– Anima in lamiera zincata sagomata e imbottitura in poliuretano espanso autoestinguente con rivestimento in tessuto Mirage.

Cuscino
– Base in legno fresato e imbottitura in poliuretano espanso autoestinguente con rivestimento in tessuto Trevira.

FR
Matériaux
Meuble
– Structure à doubles battants en mélaminé avec bords en ABS. Poignée encastrée et pieds en matière plastique.

Élément phono-absorbant
– Âme en tôle galvanisée modelée et rembourrage en polyuréthane expansé autoextinguible avec revêtement en tissu Mirage.

Coussin
– Base en bois fraisé et rembourrage en polyuréthane expansé autoextinguible avec revêtement en tissu Trevira.



EN – Warranty **IT – Garanzia**
FR – Garantie **DE – Garantie**
ES – Garantía

DE

Materialien
Mobile

– Konstruktion mit zwei kunststoffbeschichteten Flügeltüren mit ABS-Kanten. Versenkter Griff und Füße aus Kunststoff.

Schalldämmelement
– Kern aus verzinktem Formblech und Polsterung aus selbstverlöschendem Polyurethanschaum mit Bezug aus Mirage-Gewebe.

Kissen
– Sockel aus gefrästem Holz und mit selbstverlöschender Polyurethanschaumpolsterung mit Trevira-Stoffbezug.

ES

Materiales
Mueble

– Estructura con dos puertas batientes de plástico revestido con bordes de ABS. Tirador empotrado y pies de material plástico.

Elemento insonorizante
– Núcleo de chapa galvanizada moldeada y acolchado de poliuretano expandido autoextinguible tapizado con tela Mirage.

Cojín
– Base de madera fresada y acolchado de poliuretano expandido autoextinguible tapizado con tela Trevira.

EN – Colour chart leaves
IT – Cartella colori foglie
FR – Palette de couleurs feuilles
DE – Farbkarte Blätter
ES – Paleta de colores hojas

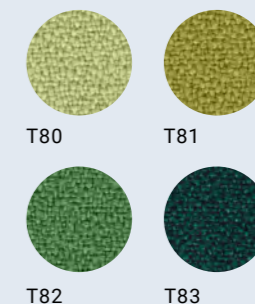

Multipurpose

Aira — p. 218

Papillon Family — p. 252

Eura Family — p. 264

Zero9 Family — p. 278

Woody — p. 308

Omnia Contract — p. 320

Hip-Up Family — p. 328

Aira

BaccoliniDesign



Aira

a·i·ra

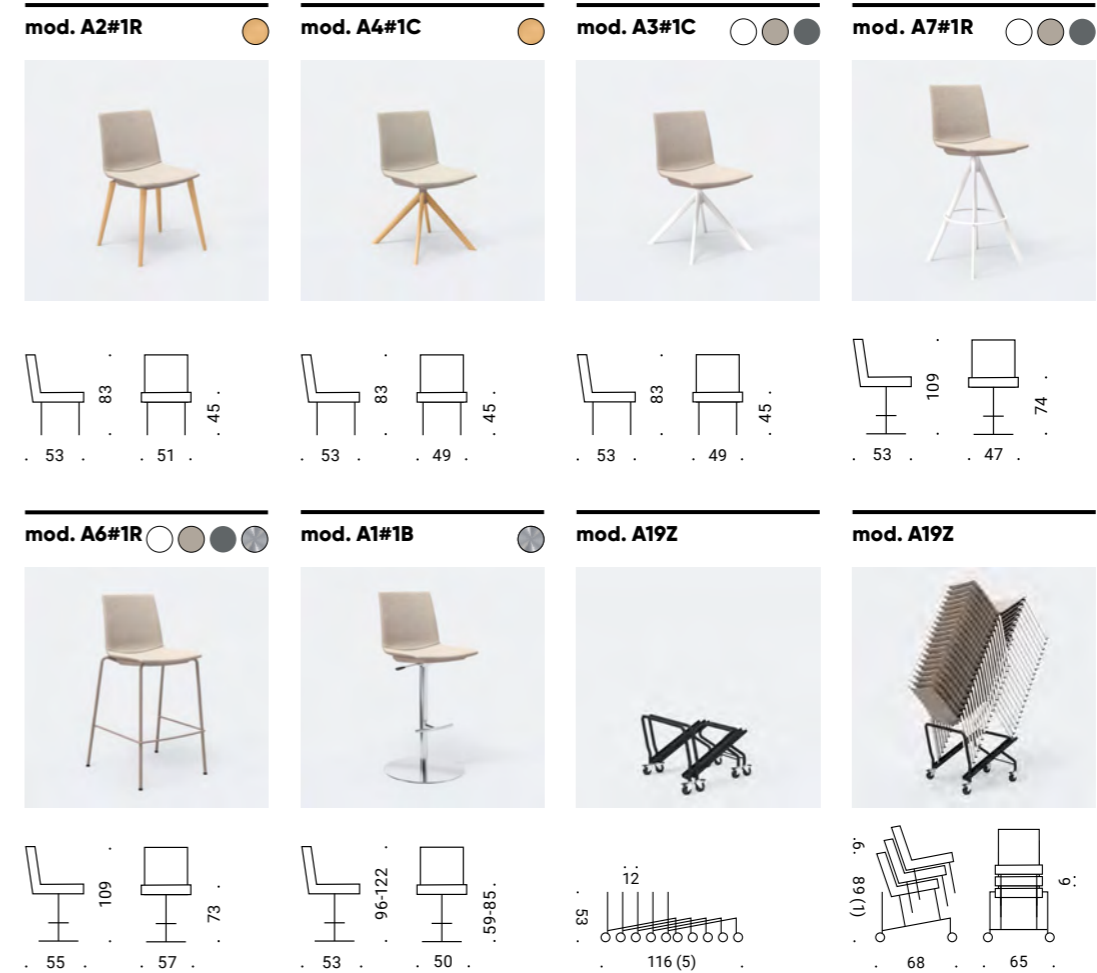
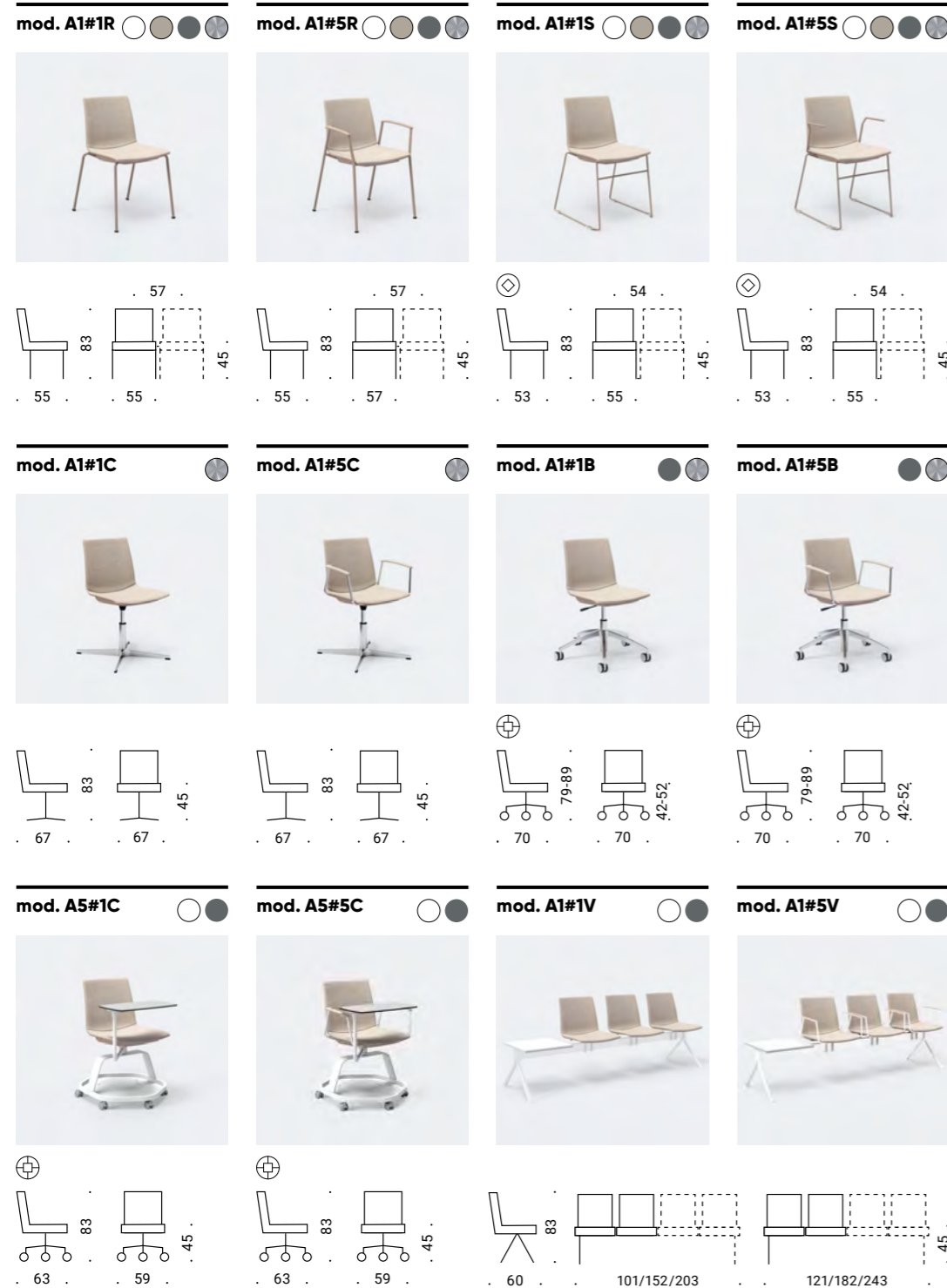

Models

Aira

EN – Recommended maximum 20 Aira per cart, height from ground 203 cm IT – Consigliate 20 Aira per carrello, altezza da terra 203 cm FR – Conseil : 20 Aira par chariot, hauteur au sol 203 cm DE – Pro Trolley werden 20 Aira empfohlen, Höhe vom Boden aus 203 cm ES – Se recomienda apilar 20 Aira por carro, altura desde el suelo: 203 cm

EN – # Shell finish IT – # Finitura scocca FR – # Finition coque DE – # Rahmenausführung ES – # Acabado del cuerpo

- (V) EN – Mono color IT – Monocolore FR – Mono-couleur DE – Einfarbig ES – Monocolor
- (W) EN – Bi-color IT – Bicolore FR – Bi-couleur DE – Zweifarbig ES – Bicolor
- (X) EN – Uph. seat IT – Sedile tap. FR – Assise tap. DE – Gep. Sitz ES – Asiento tap.
- (Y) EN – Uph. seat and back IT – Sedile e schienale tap. FR – Assise et dossier tap. DE – Sitz und Rückenlehne gep. ES – Asiento y respaldo tap.
- (T) EN – Fully uph. IT – Tutta tap. FR – Entièrement tap. DE – Alle Polster ES – Completamente tap.

EN – Frame IT – Telaio FR – Châssis DE – Gestell ES – Estructura

- White ● Taupe ● Anthracite ● Chromed ● Beech wood

- ◇ EN – Tablet IT – Tavoletta FR – Tablette DE – Schreibplatte ES – Pala
- ⊕ EN – 360° Tablet IT – Tavoletta 360° FR – Tablette 360° DE – Schreibplatte 360° ES – Pala 360°









EN

Aira with slide

- Place the tablet support behind the front leg. **(1)**
- Fasten the support to the leg. **(2)**
- Press downwards to fix the tablet. **(3)**

IT

Aira con slitta

- Posiziona il supporto tavoletta dietro la gamba anteriore. **(1)**
- Aggancia il supporto alla gamba. **(2)**
- Fai pressione verso il basso per fissare la tavoletta. **(3)**

FR

Aira avec piètement luge

- Positionner le support de la tablette derrière la jambe antérieure. **(1)**
- Accrocher le support à la jambe. **(2)**
- Faire pression vers le bas pour fixer la tablette. **(3)**

DE

Aira mit Kufengestell

- Platzieren des Tischhalters hinter dem Vorderbein. **(1)**
- Einhängen der Stütze an das Bein. **(2)**
- Zum Sichern des Tisches nach unten drücken. **(3)**

ES

Aira con base de patín

- Coloca el soporte de la pala detrás de la pata delantera. **(1)**
- Engancha el soporte a la pata. **(2)**
- Presiona hacia abajo para encajar la pala. **(3)**

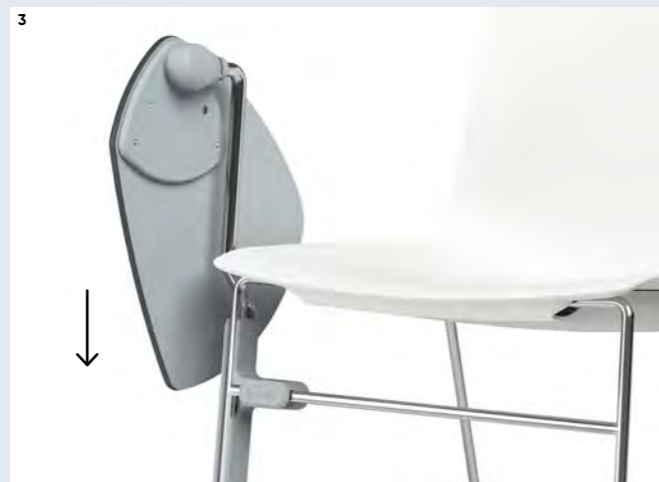
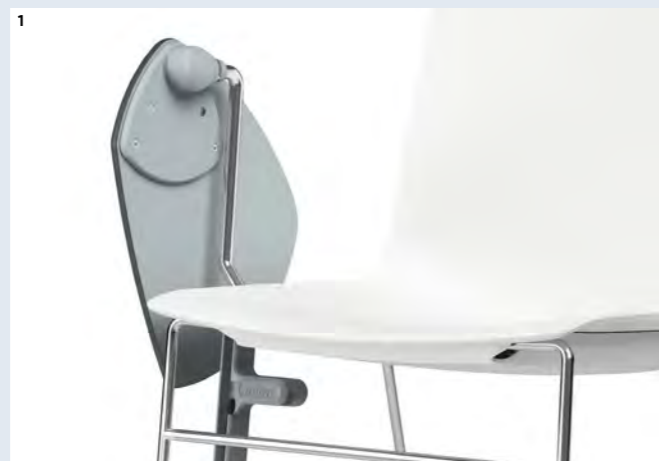



EN

Aira with slide

- Bring out the ganging devices from the underseat cover. **(1)**
- Fasten male and female. **(2)**
- Use the supplied key for locking. **(3)**

IT

Aira con slitta

- Estrai gli agganci di allineamento dal carter sotto sedile. **(1)**
- Aggancia maschio e femmina. **(2)**
- Utilizza la chiave in dotazione per il bloccaggio. **(3)**

FR

Aira avec piètement luge

- Extraire les crochets d'alignement du boîtier situé sous l'assise. **(1)**
- Accrocher le mâle avec la femelle. **(2)**
- Utiliser la clé fournie pour bloquer. **(3)**

DE

Aira mit Kufengestell

- Ziehen Sie die Ausrichtungshaken aus dem Untergestell heraus. **(1)**
- Verbinden Sie das Außen- mit dem Innengewinde. **(2)**
- Verwenden Sie den mitgelieferten Schlüssel zum Arretieren. **(3)**

ES

Aira con base de patín

- Extrae los enganches de alineación del cárter situado debajo del asiento. **(1)**
- Engancha el macho con la hembra. **(2)**
- Utiliza la llave que se incluye y bloquea los enganches. **(3)**

1



2



3







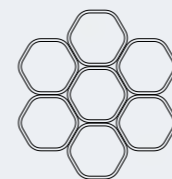





Aira GreenUp for the Planet

Good for you. Good for the Planet.

We understand your urge to take care of the planet. We want it too. So we decided to help you make a difference by doing what we do best. Seats.

IT – Aira GreenUp per il Pianeta. Giusta per te. Giusta per il Pianeta. Comprendiamo bene il tuo desiderio di prenderti cura del Pianeta, anche per noi è così. Per questo vogliamo aiutarti a fare la differenza facendo ciò che sappiamo fare meglio: sedute.

FR – Aira GreenUp pour la Planète. Respectueuse envers vous. Respectueuse envers la Planète. Nous comprenons parfaitement votre désir de prendre soin de notre Planète, il en est de même pour nous. C'est pourquoi nous souhaitons vous aider à faire la différence en faisant ce qui nous réussit le mieux : des chaises.

DE – Aira GreenUp für unsere Erde. Gut für Sie. Gut für unsere Erde. Ihr Anliegen, etwas für unsere Erde zu tun, können wir gut verstehen - auch wir möchten etwas dafür tun. Deshalb möchten wir Ihnen dabei helfen, etwas zu bewegen, indem wir das tun, was wir am besten können: Sitzmöbel.

ES – Aira GreenUp para el Planeta. Buena para ti. Buena para el Planeta. Comprendemos bien tu deseo de cuidar el Planeta, también nosotros lo queremos. Por ello, queremos ayudarte a marcar la diferencia haciendo lo que mejor sabemos hacer: sillas.

You can sit and think how to green the world. Or you can just sit.

We went back to our signature chair
- Aira - and revisited its building process.
[Say hello to Aira GreenUp.](#)

IT – Puoi sederti e pensare a come rendere il mondo più verde. Oppure semplicemente sederti. Abbiamo ripensato Aira, il nostro prodotto iconico, partendo dai suoi componenti. [Dai il benvenuto ad Aira GreenUp.](#)

FR – Il ne vous reste plus qu'à vous asseoir et à penser à comment rendre le monde plus vert. Ou tout simplement vous asseoir. Nous avons recommencé par Aira, notre produit iconique, en revisitant son processus de production. [Souhaitez la bienvenue à Aira GreenUp.](#)

DE – Sie können sich hinsetzen und darüber nachdenken, wie Sie die Welt umweltfreundlicher machen können. Oder setzen Sie sich einfach hin. Wir haben bei unserem ikonischen Produkt Aira angesetzt und dessen Herstellungsprozess grundlegend überarbeitet. [Begrüßen Sie Aira GreenUp.](#)

ES – Puedes sentarte y pensar en cómo hacer el mundo más verde. O bien simplemente sentarte. Hemos comenzado con Aira, nuestro producto icónico, repasando su proceso de producción. [Dad la bienvenida a Aira GreenUp.](#)



We convert plastic waste into a solid and long-lasting chair, with the chance to be recycled again.

IT – Abbiamo trasformato la plastica da raccolta differenziata in una sedia solida e duratura, con la possibilità di essere riciclata nuovamente.

FR – Nous avons transformé le plastique issu du tri en une chaise solide et durable, pouvant être à nouveau recyclée.

DE – Wir haben Kunststoffabfälle in einen soliden, langlebigen Stuhl verwandelt, der anschließend wieder recycelt werden kann.

ES – Hemos transformado el plástico procedente de la recogida diferenciada en una silla sólida y duradera, con la posibilidad de ser reciclada de nuevo.

Aira GreenUp is focused on sustainability and performance.



Aira GreenUp



1 Made with plastic from separate waste collection.



2 Fire retardancy Class 1.



3 Strength, durability and safety tested.

IT – Aira GreenUp è incentrata sulla sostenibilità e sulle prestazioni.
1 Generata con plastiche provenienti da raccolta differenziata.
2 Reazione al fuoco - Classe 1.
3 Testata in resistenza, durata e sicurezza.

FR – Aira GreenUp est axée sur la durabilité et la performance.
1 Générée avec des plastiques issus du tri.
2 Réaction au feu - Classe 1.
3 Test de résistance, durée et sécurité.

DE – Aira GreenUp setzt auf Nachhaltigkeit und Leistungsfähigkeit.
1 Hergestellt aus durch Mülltrennung gewonnenen recycelten Kunststoffen.
2 Brandschutzklasse 1
3 Auf Widerstandsfähigkeit, Haltbarkeit und Sicherheit getestet.

ES – Aira GreenUp se centra en la sostenibilidad y en las prestaciones.
1 Generada con plásticos procedentes de recogida diferenciada.
2 Reacción al fuego - Clase 1.
3 Prueba de resistencia, duración y seguridad.

Multipurpose

EN
Materials

- Injection moulding in polypropylene in single or two colour versions.
- Injection moulding in polypropylene with upholstered seat panel or seat panels and backrest, with padding in shape-retaining synthetic foam.
- Injection moulding in polypropylene fully upholstered with padding in shape-retaining synthetic foam and covered in fabric with contrasting stitching and matching edging.

Types

- Seat.
- Stool.
- Bench 2-3-4 seat.

Base types
Aira

- Four-leg base in chromed or varnished steel with fixed feet.
- Four-leg base in natural beech with self-levelling feet.
- Pyramidal base in varnished steel with feet.
- Pyramidal base in natural beech wood, with feet.
- Four-spoke base in polished aluminum with feet.
- Sled base in chromed or varnished steel wire with ganging device.
- Five-spoke base in polished aluminum or nylon with castors. The self-braking swivel castors are in nylon for soft flooring or with polyurethane tread for hard flooring. The fixed feet are in nylon.
- Huddle space base with varnished steel basket and castors. The self-braking swivel castors are with polyurethane tread for hard flooring.

Aira stool

- Four-leg base in chromed or varnished steel with footrest and feet.
- Pyramidal base in varnished steel with footrest and feet.
- Disk base in chromed stainless steel with footrest.

Aira bench

- Base and legs in varnished steel, with feet (adjustable).

Mechanisms
Aira

- Swivel seat in pyramidal base and four-spoke versions.
- In the five-spoke version with castors, seat height adjustment with gas cylinder.

Aira stool with disk base

- Seat height adjustment with gas cylinder.

Optional accessories
Aira

- Underseat casing. Always recommended for upholstered versions that need to be stackable.

Aira

Aira and Aira bench

- Armrests with polypropylene top matching the shell or upholstered.

Aira with sled base

- Armrests in steel wire.
- Anti-panic writing tablet with rapid coupling-uncoupling mechanism.

Aira with five-spoke base and huddle space

- Ambidextrous 360° rotating writing tablet in grey HPL with support arm in black or white varnished steel.

Aira bench

- Side table.

IT
Materiali

- Monoscocca in polipropilene stampata a iniezione in versione mono o bicolore.
- Monoscocca in polipropilene stampata a iniezione con pannello sedile o pannelli sedile e schienale tappezzati, con imbottitura in resine espanse indeformabili.
- Monoscocca in polipropilene stampata a iniezione completamente tappezzata, imbottita in resine espanse indeformabili e rivestita in tessuto con cuciture a contrasto e bordino in tinta.

Tipologie

- Sedia.
- Sgabello.
- Panca 2-3-4 posti.

Tipologie di base
Aira

- Base a quattro gambe in tubo di acciaio cromato o verniciato con piedini fissi.
- Base a quattro gambe in legno di faggio naturale con piedini autolivellanti.
- Base piramidale in acciaio verniciato con piedini.
- Base piramidale in legno di faggio naturale, con piedini.
- Base a quattro razze in alluminio lucidato con piedini.
- Base a slitta in filo d'acciaio cromato o verniciato con piedini con gancio di allineamento.
- Base a cinque razze in alluminio lucidato o nylon con ruote. Le ruote piroettanti autofrenanti sono in nylon per suolo morbido o con battistrada in poliuretano per suolo duro. I piedini fissi sono in nylon.
- Base huddle space con cestone in acciaio verniciato e ruote. Le ruote sono piroettanti autofrenanti con battistrada in poliuretano per suolo duro.

Aira sgabello

- Base a quattro gambe in acciaio cromato o verniciato con poggiapiedi e piedini.
- Base piramidale in acciaio verniciato con poggiapiedi e piedini.
- Base a disco in acciaio inox cromato con poggiapiedi.

Aira panca

- Trave e gambe in acciaio verniciato, con piedini (regolabili).

Meccanismi
Aira

- Nella versione a base piramidale o quattro razze, seduta girevole.
- Nella versione a cinque razze con ruote, regolazione in altezza della seduta con colonna a gas.

Aira sgabello con base a disco

- Regolazione in altezza della seduta con colonna a gas.

Accessori opzionali
Aira

- Carter sotto sedile. Sempre consigliato nelle versioni tappezzate con esigenze di impilabilità.

Aira e Aira panca

- Braccioli con top in polipropilene in tinta con la scocca o tappezzato.

Aira su slitta

- Braccioli in filo d'acciaio.
- Tavoletta di scrittura con movimento antipanico con dispositivo di aggancio / sgancio rapido.

Aira cinque razze e huddle space

- Tavoletta ambidestra girevole 360° in HPL grigio con braccio di supporto in acciaio verniciato nero o bianco.

Aira panca

- Tavolino.

FR
Matériaux

- Monocoque en polypropylène moulée par injection en version mono-couleur ou bi-couleur.
- Monocoque en polypropylène moulée par injection avec panneau assise ou panneaux assise et dossier tapissés, avec rembourrage en résines expansées indéformables.
- Monocoque en polypropylène moulée par injection complètement tapissée, rembourrée de résines expansées indéformables et revêtue de tissu avec coutures contrastantes et passepoil du même ton.

Types

- Chaise.
- Tabouret.
- Banquette 2-3-4 places.

Types de piètement
Aira

- Piètement à quatre jambes en tubes d'acier chromé ou verni avec pieds fixes.
- Piètement à quatre jambes en bois de hêtre naturel avec pieds autonivelants.
- Piètement pyramidal

Aira

en acier verni avec pieds.

- Piètement pyramidal en bois de hêtre naturel, avec pieds.
- Piètement à quatre branches en aluminium finition polie avec pieds.
- Piètement luge en fil d'acier chromé ou verni avec pieds et crochet d'alignement.
- Piètement à cinq branches en aluminium finition polie ou nylon avec roulettes. Les roulettes pivotantes autofreinantes sont en nylon pour sol souple ou avec chape en polyuréthane pour sol dur. Les pieds fixes sont en nylon.
- Piètement huddle space avec panier en acier verni et roulettes. Les roulettes pivotantes autofreinantes sont avec chape en polyuréthane pour sol dur.

Aira tabouret

- Piètement à quatre jambes en acier chromé ou verni avec repose-pieds et pieds.
- Piètement pyramidal en acier verni avec repose-pieds et pieds.
- Piètement à disque en acier inox chromé avec repose-pieds.

Aira banquette

- Poutre et jambes en acier verni, avec pieds (réglables).

Mécanismes
Aira

- Dans la version avec piètement pyramidal ou à quatre branches, assise pivotante.
- Dans la version à cinq branches avec roulettes, réglage en hauteur du siège avec vérin à gaz.

Aira tabouret avec piètement à disque

- Réglage en hauteur du siège avec vérin à gaz.

Accessoires en option
Aira

- Boîtier situé sous l'assise. Toujours conseillé dans les versions tapissées avec exigences de sièges empilables.

Aira et Aira banquette

- Accoudoirs avec partie supérieure en polypropylène du même ton que la structure ou tapissée.

Aira avec piètement luge

- Accoudoirs en fil d'acier.
- Tablette anti-panique avec mécanisme d'accrochage / décrochage rapide.

Aira à cinq branches et huddle space

- Tablette ambidextre pivotante à 360° en HPL gris avec bras de support en acier verni noir ou blanc.

Aira banquette

- Table basse.

Aira

DE
Materialien

- Einsitzer aus spritzgegossenem Polypropylen in ein- oder zweifarbiger Ausführung.
- Einzelchale aus spritzgegossenem Polypropylen mit Sitzplatte oder verkleideten Sitz- und Rückenplatten, mit formstabiler Schaumstoffpolsterung.
- Einzelchale aus spritzgegossenem Polypropylen, komplett verkleidet, gepolstert mit formstabilen Schaumstoffen und stoffbezogen mit Kontrastnähten und passender Paspel.

Typen

- Stuhl.
- Hocker.
- Bank mit 2-3-4 Sitzplätzen.

Grundmodelle
Aira

- Standfuß mit vier Beinen aus verchromtten oder lackiertem Stahl mit festen Füßen.
- Standfuß mit vier Beinen aus naturbelassenem Buchenholz mit selbstausrichtenden Füßen.
- Pyramidenfuß aus lackiertem Stahl, mit Füßen.
- Pyramidenfuß aus naturbelassenem Buchenholz, mit Füßen.
- Vierarmiges Fußkreuz aus poliertem Aluminium mit Füßen.
- Kufengestell aus Stahldraht, verchromt oder lackiert, mit Füßen, mit Ausrichtungshaken.
- Fünfarmiges Fußkreuz aus poliertem Aluminium oder Nylon mit Füßen. Die selbstbremsenden Lenkrollen bestehen für weiche Böden aus Nylon und sind für harte Böden mit einer Polyurethan-Laufläche ausgestattet. Die Standfüße sind aus Nylon gefertigt.
- Standfuß Huddle Space mit lackiertem Stahlkorb und Rädern. Die selbstbremsenden Lenkrollen sind für harte Böden mit einer Polyurethan-Laufläche ausgestattet.

Aira Hocker

- Verchromter oder lackierter Standfuß mit vier Stahlbeinen mit Fußstütze und Füßen.
- Pyramidenfuß aus lackiertem Stahl mit Fußstütze und Füßen.
- Tellerfuß aus verchromtem Edelstahl mit Fußstützen.

Aira Bank

- Träger und Beine aus lackiertem Stahl, mit Füßen (verstellbar).

Funktionen
Aira

- In der Ausführung mit Pyramidenfuß oder vier Speichen, schwenkbarer Sitz.
- In der Fünf-Speichen-Version mit Rädern, Sitzhöhenverstellung mit Gasdruckfeder.

Aira Hocker mit Tellerfuß

- Sitzhöhenverstellung mit Gasdruckfeder.

Sonderzubehörteile
Aira

- Abdeckung unter dem Sitz. Immer empfohlen bei gepolsterten Ausführungen, die gestapelt werden müssen.

Aira und Aira Bank

- Armlehnen mit Polypropylen-Oberfläche in der gleichen Farbe wie der Korpus oder der Bezug.

Aira mit Kufengestell

- Armlehnen aus Stahldraht.
- Anti-Panik-Tafel aus HPL mit abgerundeten Kanten in Aluminiumgrau.

Aira mit fünf Speichen und Huddle Space

- Drehbare Anti-Panik-Tafel aus HPL mit abgerundeten Kanten in Aluminiumgrau.

Aira Bank

- Kleiner Tisch.

ES
Materiales

- Monocasco de polipropileno moldeado por inyección en versión monocolor o bicolor.
- Monocasco de polipropileno moldeado por inyección con panel o paneles de asiento y respaldos tapizados, con acolchado de resina expandida indeformable.
- Monocasco de polipropileno moldeado por inyección completamente tapizado, acolchado con resinas expandidas indeformables y tapizado con tela con costuras en contraste y ribetes a juego.

Tipos

- Silla.
- Taburete.
- Bancada 2-3-4 plazas.

Tipos de base
Aira

- Base de cuatro patas en tubular de acero cromado o pintado con pies fijos.
- Base de cuatro patas de madera de haya natural con pies autonivelantes.
- Base piramidal de acero pintado, con pies.
- Base piramidal de madera de haya natural, con pies.
- Base de cuatro radios en aluminio pulido, con pies.
- Base de patín de alambre de acero cromado o pintado, con pies con gancho de alineación.
- Base de cinco radios de aluminio pulido o nailon con ruedas. Las ruedas, giratorias y autofrenantes, están fabricadas en nailon para suelos blandos y con banda de poliuretano para suelos duros. Los pies fijos son de nailon.
- Base huddle space con cesta y ruedas de acero pintado. Las ruedas son giratorias y autofrenantes, con banda de poliuretano para suelos duros.

Multipurpose

Aira taburete
 – Base de cuatro patas de acero cromado o pintado, con reposapiés y pies.
 – Base piramidal de acero pintado con reposapiés y pies.
 – Base de disco de acero inoxidable cromado con reposapiés.

Aira bancada
 – Viga y patas de acero pintado, con pies (regulables).

Mecanismos

Aira
 – En la versión de base piramidal o de cuatro radios, asiento giratorio.
 – En la versión de cinco radios con ruedas, ajuste de altura del asiento con pistón a gas.

Aira taburete con base de disco
 – Altura del asiento regulable con pistón a gas.

Accesorios opcionales

Aira
 – Cárter debajo del asiento, recomendado siempre en las versiones tapizadas que necesiten ser apiladas.

Aira silla y bancada
 – Brazos con parte superior en polipropileno a juego con el cuerpo o tapizada.

Aira con base de patín
 – Brazos en alambre de acero.
 – Pala de escritura antipánico con dispositivo de enganche/desenganche rápido.

Aira de cinco radios y huddle space
 – Pala de escritura ambidiestra giratoria 360° en HPL gris con brazo de soporte en acero pintado negro o blanco.

Aira bancada
 – Mesita.

EN

Shell finish
 V – Mono color
 W – Bi-color
 X – Upholstered seat
 Y – Upholstered seat and backrest
 T – Fully upholstered with contrasting stitching and edging
 G – Fire-retardant and recycled polypropylene shell

Types
 1 – 4-leg base
 2 – 4-leg base with armrests
 3 – 4 wooden legs
 4 – Pyramidal
 5 – 4-spoke base
 6 – 4-spoke base with armrests
 7 – Sled base
 8 – Sled base with armrests
 9 – 5-spoke base
 10 – 5-spoke base with armrests

Aira

11 – Huddle space base
 12 – Huddle space base with armrests
 13 – Bench
 14 – Bench with armrests
 15 – Disk base for stool
 16 – Pyramidal base for stool
 17 – 4-leg base for stool

IT

Finitura scocca
 V – Monocolore
 W – Bicolore
 X – Sedile tappezzato
 Y – Sedile e schienale tappezzati
 T – Tutta tappezzata con cuciture e bordino a contrasto
 G – Monoscocca in polipropilene ignifugo e riciclato

Tipologie

1 – 4 gambe
 2 – 4 gambe con braccioli
 3 – 4 gambe in legno
 4 – Piramidale
 5 – 4 razze
 6 – 4 razze con braccioli
 7 – Slitta
 8 – Slitta con braccioli
 9 – 5 razze
 10 – 5 razze con braccioli
 11 – Huddle space
 12 – Huddle space con braccioli
 13 – Panca
 14 – Panca con braccioli
 15 – Base a disco per sgabello
 16 – Piramidale per sgabello
 17 – 4 gambe per sgabello

FR

Finition coque
 V – Mono-couleur
 W – Bi-couleur
 X – Assise tapissée
 Y – Assise et dossier tapissés
 T – Entièrement tapissée avec coutures et bords contrastants
 G – Monocoque en polypropylène ignifugé et recyclé

Types

1 – 4 jambes
 2 – 4 jambes avec accoudoirs
 3 – 4 jambes en bois
 4 – Pyramidal
 5 – 4 branches
 6 – 4 branches avec accoudoirs
 7 – Luge
 8 – Luge avec accoudoirs
 9 – 5 branches
 10 – 5 branches avec accoudoirs
 11 – Huddle Space
 12 – Huddle Space avec accoudoirs
 13 – Banquette
 14 – Banquette avec accoudoirs

15 – Piètement à disque pour tabouret
 16 – Pyramidal pour tabouret
 17 – 4 branches pour tabouret

DE

Rahmenausführung
 V – Einfarbig
 W – Zweifarbig
 X – Gepolsterter Sitz
 Y – Sitz und Rückenlehne gepolstert
 T – Alle Polster mit kontrastierenden Ziernähten und Einfassungen
 G – Sitzschale aus recyceltem feuerhemmendem Polypropylen

Typenübersicht

1 – 4 Beine
 2 – 4 Beine mit Armlehnen
 3 – 4 Holzbeine
 4 – Pyramidenfuß
 5 – Vierarmig
 6 – Vierarmig mit Armlehnen
 7 – Kufengestell
 8 – Kufengestell mit Armlehnen
 9 – Fünfarmig
 10 – Fünfarmig mit Armlehnen
 11 – Huddle Space
 12 – Huddle Space mit Armlehnen
 13 – Bank
 14 – Bank mit Armlehnen
 15 – Scheibenfuß für Hocker
 16 – Pyramidenfuß für Hocker
 17 – 4 Beine für Hocker

ES

Acabado del cuerpo
 V – Monocolor
 W – Bicolor
 X – Asiento tapizado
 Y – Asiento y respaldo tapizados
 T – Completamente tapizada con costuras y ribetes en contraste
 G – Monocasco en polipropileno ignífugo y reciclado

Tipos

1 – 4 patas
 2 – 4 patas con brazos
 3 – 4 patas de madera
 4 – Piramidal
 5 – 4 radios
 6 – 4 radios con brazos
 7 – Patín
 8 – Patín con brazos
 9 – 5 radios
 10 – 5 radios con brazos
 11 – Huddle space
 12 – Huddle space con brazos
 13 – Bancada
 14 – Bancada con brazos
 15 – Base de disco para taburete
 16 – Piramidal para taburete
 17 – 4 patas para taburete

Aira

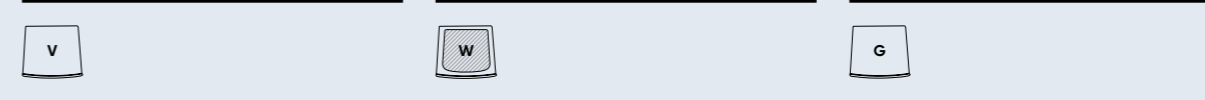

Dove grey
 Tortora
 Tourterelle
 Taubengrau
 Tórtola

White + dove grey
 Bianco + tortora
 Blanc + tourterelle
 Weiß + Taubengrau
 Blanco + tórtola

Anthracite
 Antracite
 Anthracite
 Anthrazit
 Antracita

Silk grey
 Grigio seta
 Gris soie
 Seidengrau
 Gris seda

White + silk grey
 Bianco + grigio seta
 Blanc + gris soie
 Weiß + Seidengrau
 Blanco + gris seda

Light denim
 Denim chiaro
 Denim clair
 Helles Jeansblau
 Denim claro

White + light denim
 Bianco + denim chiaro
 Blanc + denim clair
 Weiß + Helles Jeansblau
 Blanco + denim claro

Bronte geen
 Verde Bronte
 Vert Bronte
 Bronte-Grün
 Verde Bronte

White + Bronte geen
 Bianco + verde Bronte
 Blanc + vert Bronte
 Weiß + Bronte-Grün
 Blanco + verde Bronte

Red
 Rosso
 Rouge
 Rot
 Rojo

White + red
 Bianco + rosso
 Blanc + rouge
 Weiß + Rot
 Blanco + rojo

Anthracite
 Antracite
 Anthracite
 Anthrazit
 Antracita

White + anthracite
 Bianco + antracite
 Blanc + anthracite
 Weiß + Anthrazit
 Blanco + antracita

White
 Bianco
 Blanc
 Weiß
 Blanco



EN – Warranty IT – Garanzia
FR – Garantie DE – Garantie
ES – Garantía

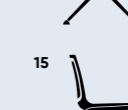
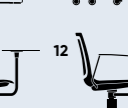
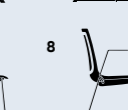
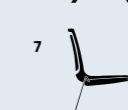
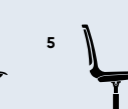
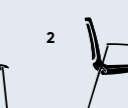
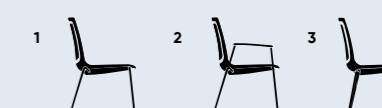

Papillon Family

Papillon



BaccolinDesign

Papillon Comfort



Papillon Family

mod. 805Q

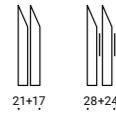
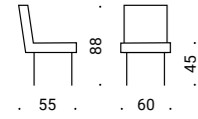

mod. 805Q XL

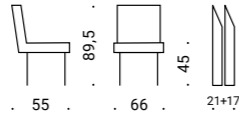

mod. 895

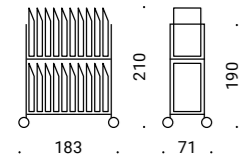

mod. 895 SP8

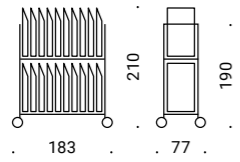

mobile ganging clip

fix ganging clip

floor ganging clip

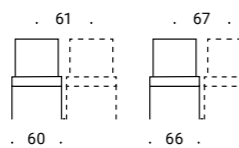
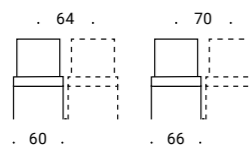
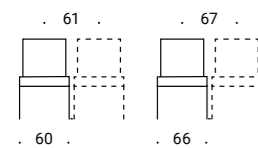

Models

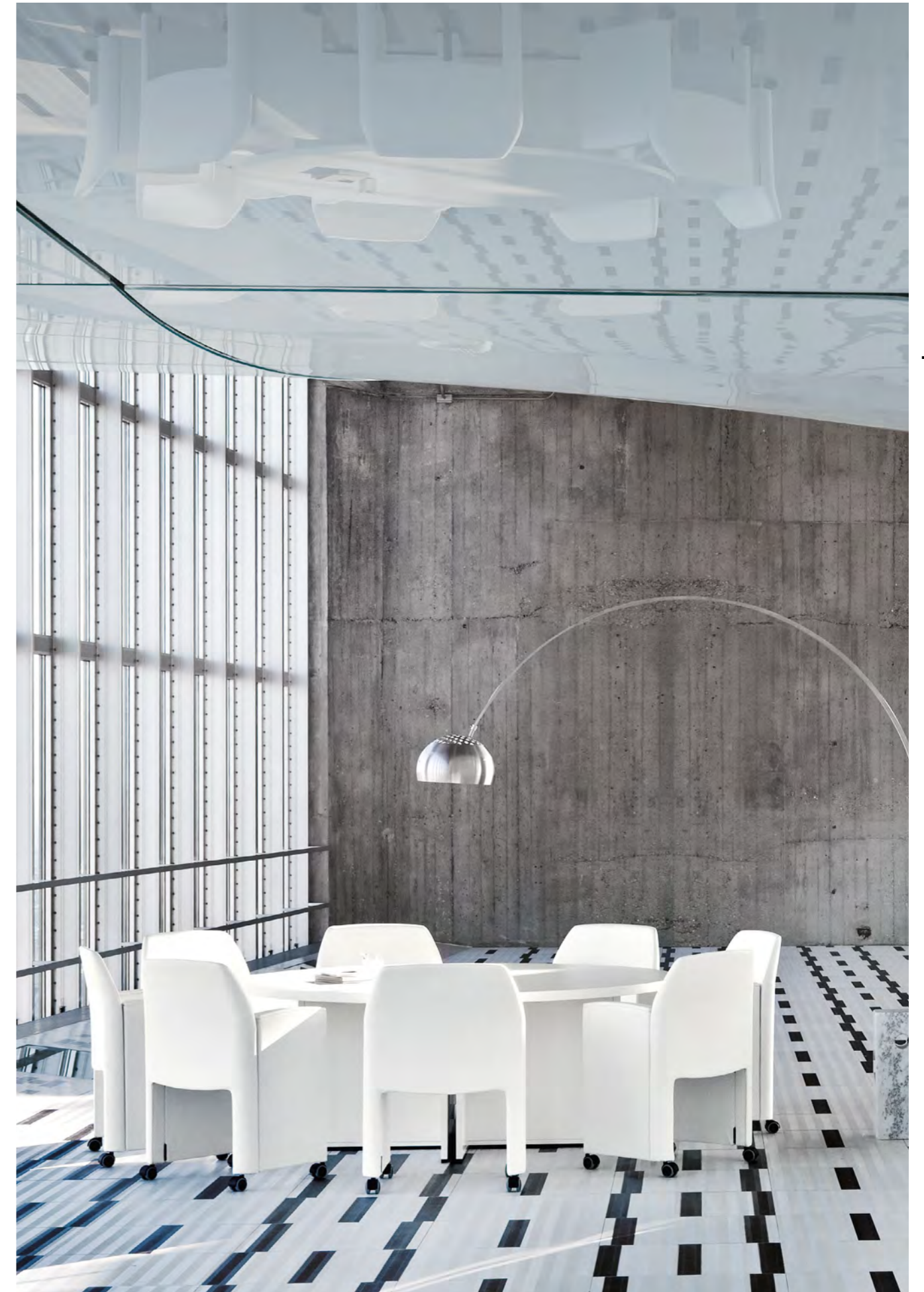

Papillon





EN – Trolley for n° 20 Papillon or n° 14 Papillon with writing tablet. **IT** – Carrello per n° 20 Papillon o n° 14 Papillon con tavoletta di scrittura. **FR** – Chariot pour n.20 sièges Papillon ou n.14 sièges Papillon avec tablette écrite. **DE** – Trolley für 20 Papillon oder 14 Papillon mit Schreibplatte. **ES** – Carro para 20 Papillon o 14 Papillon con pala de escritura.

mod. 805Q R



mod. 805Q RXL

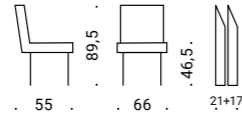
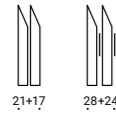
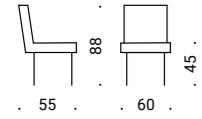

mod. 895



mod. 895 SP8

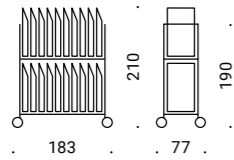
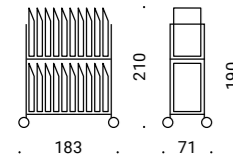

mobile ganging clip

fix ganging clip

floor ganging clip

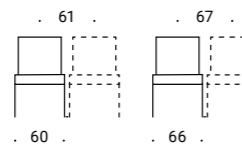
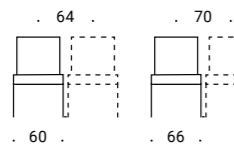
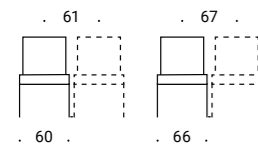

Models

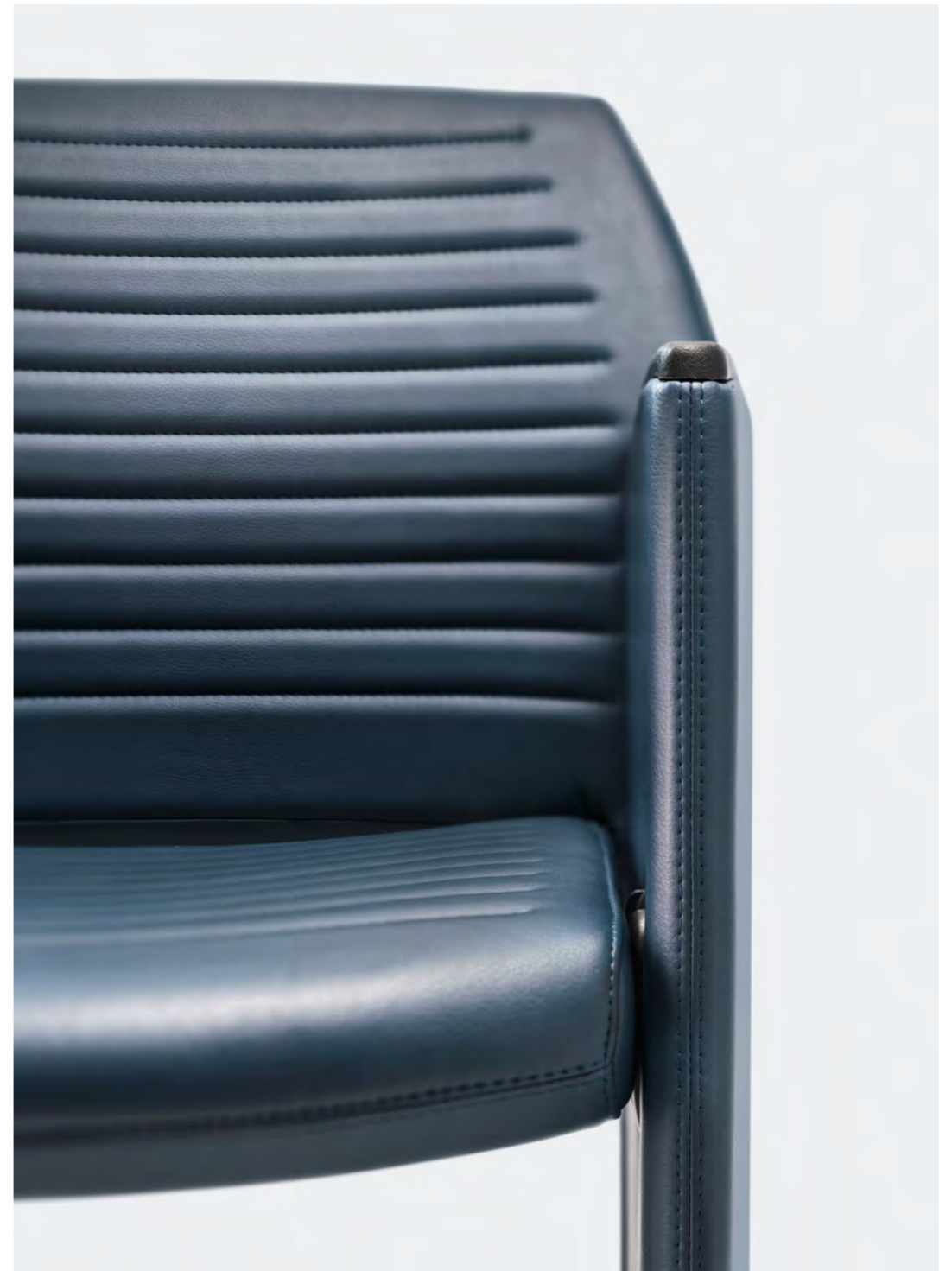

Papillon Comfort

EN

Materials

Papillon and Papillon Comfort

– Seat, backrest and side in tubular steel of different dimensions, with closure ensured by a system of steel hooks and zips. Padded elements in cold-moulded self-extinguishing polyurethane.

Papillon XL and Papillon Comfort XL

– Seat in beech plywood upholstered in flexible self-extinguishing polyurethane, with closure ensured by a system of steel hooks and zips. Sides and backrest in tubular steel with padding in cold-moulded self-extinguishing polyurethane.

Armrests

All models

– With armrest in polypropylene.
– With armrest in upholstered polypropylene.
– With armrest in solid varnished beech.

Base types

All models

– Self-braking swivel castors in nylon for soft flooring or with polyurethane tread for hard flooring.
– Fixed feet in reinforced nylon.
– Feet with rubber sucker and pin in galvanized steel.

Optional accessories

All models

– Writing tablet in black polypropylene with anti-panic mechanism in polished die-cast aluminium. **(1)**
– Short ganging device in steel wire. **(2-3)**
– Long ganging device in steel plate. **(4)**
– Floor ganging device. **(5)**

IT

Materiali

Papillon e Papillon Comfort

– Seduta, schienale e fianco in tubolare d'acciaio di varie dimensioni, con chiusura garantita da un sistema di agganci e cerniere in acciaio. Parti imbottite in poliuretano autoestingente schiumato a freddo.

Papillon XL e Papillon Comfort XL

– Seduta in legno multistrato di faggio con imbottitura in poliuretano flessibile autoestingente, con chiusura garantita da un sistema di agganci e cerniere in acciaio. Parti imbottite in poliuretano autoestingente schiumato a freddo. Interno sedile e schienale in multistrato di faggio, fianchi in tubolare d'acciaio.

Braccioli

Tutti i modelli

– Con poggiatesta in polipropilene.
– Con poggiatesta in polipropilene rivestito.
– Con poggiatesta in legno massello di faggio verniciato.

Tipologie di base

Tutti i modelli

– Ruote piroettanti autofrenanti in nylon per suolo morbido o con battistrada in poliuretano per suolo duro.
– Piedini fissi in nylon caricato.
– Piedini con ventosa in gomma con perno in acciaio zincato.

Accessori opzionali

Tutti i modelli

– Tavoleta scrittoio in polipropilene nero con movimento antipánico in alluminio pressofuso lucidato. **(1)**
– Gancio di allineamento corto in filo d'acciaio. **(2-3)**
– Gancio di allineamento lungo in lamiera d'acciaio. **(4)**
– Gancio di allineamento a terra. **(5)**

FR

Matériaux

Papillon et Papillon Comfort

– Siège, dossier et flancs en tubes d'acier de différentes dimensions avec fermeture assurée par un système de crochets et de charnières en acier. Parties rembourrées en mousse de polyuréthane autoextinguible moulée à froid.

Papillon XL et Papillon Comfort XL

– Siège en bois de hêtre multicouche avec rembourrage en polyuréthane flexible autoextinguible et fermeture assurée par un système de crochets et de charnières en acier. Flancs et dossier en tubes d'acier avec parties rembourrées en mousse de polyuréthane autoextinguible moulée à froid.

Accoudoirs

Tous les modèles

– Avec repose-bras en polypropylène.
– Avec repose-bras en polypropylène revêtu.
– Avec repose-bras en hêtre massif verni.

Types de piètement

Tous les modèles

– Roulettes pivotantes autofreinantes en nylon pour sol souple ou avec chape en polyuréthane pour sol dur.
– Pieds fixes en nylon renforcé.
– Pieds avec ventouse en caoutchouc avec cheville en acier galvanisé.

Accessoires en option

Tous les modèles

– Tablette écriteoire en polypropylène noir avec mouvement anti-panique en aluminium moulé sous pression finition polie. **(1)**
– Crochet d'alignement court en fil d'acier. **(2-3)**
– Crochet d'alignement long en tôle d'acier. **(4)**
– Crochet d'alignement au sol. **(5)**

DE

Materialien

Papillon und Papillon Comfort

– Sitz, Rücken- und Seitenlehne aus Stahlrohr in verschiedenen Größen, mit einem Schließsystem aus Stahlhaken und -scharnieren. Teile mit selbstlöschendem, kaltgeschäumtem Polyurethan gepolstert.

Papillon XL und Papillon Comfort XL

– Sitz aus Buchensperrholz mit flexibler, selbstverlöschender Polyurethan-Polsterung in mit einem Schließsystem aus Stahlhaken und -scharnieren. Seiten- und Rückenlehne aus Stahlrohr mit Polsterteilen aus selbstverlöschendem Polyurethanschaum.

Armlehnen

Alle Modelle

– Mit Armlehne aus Polypropylen.
– Mit Armlehne aus beschichtetem Polypropylen.
– Mit Armlehne aus lackiertem Buchenmassivholz.

Grundmodelle

Alle Modelle

Selbstbremsende Lenkrollen aus Nylon für weiche Böden oder mit Polyurethan-Laufläche für harte Böden.
– Feste Füße aus verstärktem Nylon.
– Füße mit Saugnapf und verzinktem Stahlstift.

Sonderzubehöriteile

Alle Modelle

– Schreibplatte aus schwarzem Polypropylen mit Anti-Panik-Funktion aus poliertem Aluminiumdruckguss. **(1)**
– Kurze Reihenverbindung aus Stahldraht. **(2-3)**
– Lange Reihenverbindung aus Stahlblech. **(4)**
– Reihenverbindung am Boden befestigt. **(5)**

ES

Materiales

Papillon y Papillon Comfort

– Asiento, respaldo y laterales en tubular de acero de varias medidas, con cierre garantizado por un sistema de enganches y bisagras de acero. Partes acolchadas de poliuretano autoextinguible espumado en frío.

Papillon XL y Papillon Comfort XL

– Asiento de madera multicapa de haya con acolchado de poliuretano flexible autoextinguible con cierre garantizado por un sistema de enganches y bisagras de acero. Laterales y respaldo en tubular de acero con partes acolchadas de poliuretano autoextinguible espumado en frío.

Brazos

Todos los modelos

– Con reposabrazos de polipropileno.
– Con reposabrazos de polipropileno tapizado.
– Con reposabrazos de madera maciza de haya barnizada.

Tipos de base

Todos los modelos

– Ruedas giratorias autofrenantes en nailon para suelos blandos y con banda de poliuretano para suelos duros.
– Pies fijos de nailon reforzado.
– Pies con ventosa de goma con pasador de acero galvanizado.

Accesorios opcionales

Todos los modelos

– Pala de escritura de polipropileno negro con movimiento antipánico en aluminio pulido fundido a presión. **(1)**
– Gancho de alineación corto en alambre de acero. **(2-3)**
– Gancho de alineación largo en chapa de acero. **(4)**
– Gancho de alineación en el suelo. **(5)**

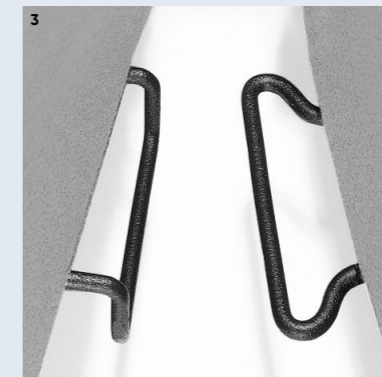
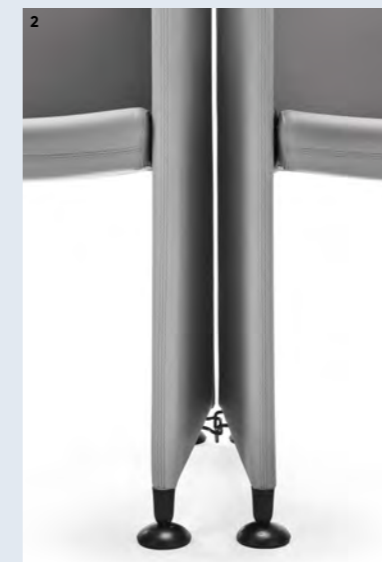

EN – Warranty IT – Garanzia
FR – Garantie DE – Garantie
ES – Garantía

Eura Family

Eura Visitor



BaccoliniDesign

Eura Conference



Eura Family

mod. 1105S TP

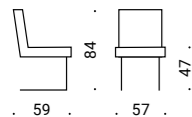
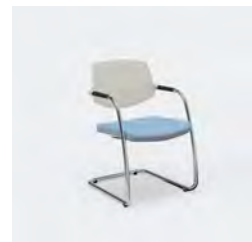

mod. 1105S TI

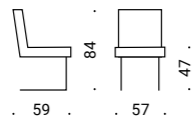
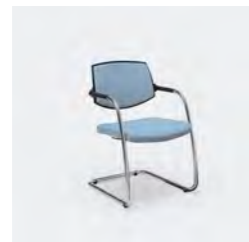

mod. 1105S TR

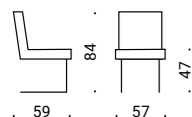
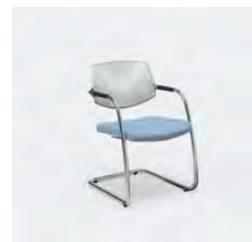

mod. 1105S TT

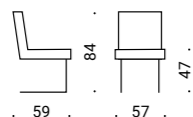
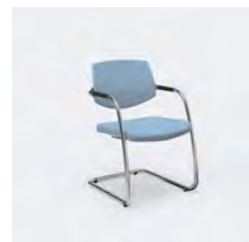

EN – Combinations of seat and backrest IT – Combinazioni schienale e sedile FR – Combinaisons dossier et assise DE – Rückenlehnen-Sitzkombination ES – Combinaciones respaldo y asiento

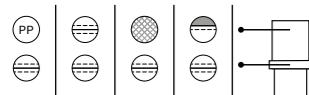

PP EN – Polypropylene
IT – Polipropilene
FR – Polypropylène
DE – Polypropylen
ES – Polipropileno

U EN – Upholstered
IT – Tapezzato
FR – Tapissée
DE – Stoffbezogen
ES – Tapizada

M EN – Mesh
IT – Rete
FR – Résille
DE – Netzgewebe
ES – Malla

P EN – Plastic with upholstered panel
IT – Plastica con pannello tappezzato
FR – Plastique avec panneau tapissé
DE – Kunststoff mit gepolstertem Panel
ES – Plástico con panel tapizado

Models



Eura Visitor



mod. 1105R TP

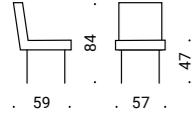
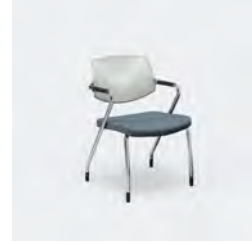

mod. 1105R TI

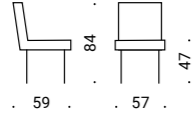
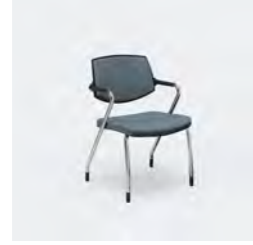

mod. 1105R TR

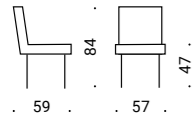
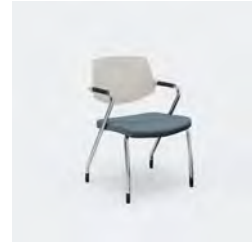

mod. 1105R TT

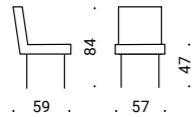
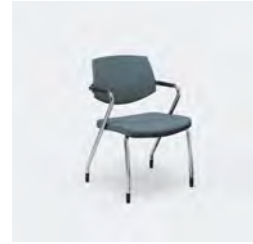

EN – Combinations of seat and backrest IT – Combinazioni schienale e sedile FR – Combinaisons dossier et assise DE – Rückenlehnen-Sitzkombination ES – Combinaciones respaldo y asiento

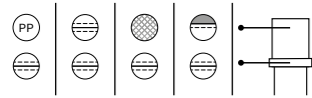

PP EN – Polypropylene
IT – Polipropilene
FR – Polypropylène
DE – Polypropylen
ES – Polipropileno

Upholstered EN – Upholstered
IT – Tapezzato
FR – Tapissée
DE – Stoffbezogen
ES – Tapizada

Mesh EN – Mesh
IT – Rete
FR – Résille
DE – Netzgewebe
ES – Malla

Plastic with upholstered panel EN – Plastic with upholstered panel
IT – Plastica con pannello tappezzato
FR – Plastique avec panneau tapissé
DE – Kunststoff mit gepolstertem Panel
ES – Plástico con panel tapizado

Models



Eura Conference





EN

Materials

All models

– Seat in natural beech plywood padded and upholstered, with padding in self-extinguishing shape-retaining synthetic foam. Supporting frame in asform tubular steel chromed or epoxy powder coated. Armrests upholstered in “soft touch” elastomer.

Types of backrest

All models

– Backrest in natural beech plywood with padding in self-extinguishing shape-retaining synthetic foam with upholstery.
– Backrest in polypropylene injection moulded with anti-slip surface finish, in white and translucent white.
– Backrest with coated steel rod frame and covered in mesh.
The rear backrest supports are in black nylon in the versions with black frame and in polished aluminium in the chromed frame versions. In the polypropylene backrest version the support, moulded together with the backrest, is in the same material.

Base types

Eura Visitor
– Sled base.

Eura Conference

– Four-leg base with double tread self-braking swivel castors in nylon for soft flooring or with polyurethane tread for hard flooring.
– Four-leg base with reinforced nylon feet.

Optional accessories

Eura Conference

– Writing tablet in black polypropylene with anti-panic mechanism in polished die-cast aluminium.
– Seat base in injection moulded polypropylene with alignment coupling ganging device with quick locking system in steel wire. **(1–3)**

IT

Materiali

Tutti i modelli

– Sedile in legno multistrato di faggio naturale imbottito e tappezzato, con imbottitura in resine espanse indeformabili autoestinguenti. Telaio portante in tubolare d'acciaio asform cromato o verniciato a polveri epossidiche. Coperture dei braccioli in elastomero “soft touch”.

Tipologie di schienale

Tutti i modelli

– Schienale in legno multistrato di faggio naturale con imbottitura in resine

espanse indeformabili autoestinguenti e rivestimento.

– Schienale in polipropilene stampato a iniezione con finitura superficiale antiscivolo, nei colori nero e bianco traslucido.
– Schienale con struttura in tondino d'acciaio verniciato e rivestimento in rete. *I supporti posteriori dello schienale sono in nylon nero nelle versioni con telaio nero e in alluminio lucidato nelle versioni con telaio cromato. Nella versione con schienale in polipropilene il supporto, co-stampato con lo schienale, è nello stesso materiale.*

Tipologie di base

Eura Visitor

– Base a slitta.

Eura Conference

– Base a quattro gambe con ruote piroettanti autofrenanti a doppia carreggiata in nylon per suolo morbido o con battistrada in poliuretano per suolo duro.
– Base a quattro gambe con piedini in nylon caricato.

Accessori opzionali

Eura Conference

– Tavoletta scrittoio in polipropilene nero con movimento antipánico in alluminio pressofuso lucidato.
– Sotto sedile in polipropilene stampato a iniezione con gancio di allineamento a scomparsa in filo d'acciaio. **(1–3)**

FR

Matériaux

Tous les modèles

– Assise en bois de hêtre naturel multiplis rembourré et tapissé, avec rembourrage en résines expansées indéformables autoextinguibles. Structure portante en tubes d'acier « asform » chromé ou verni par poudre époxy. Manchettes d'appui confort des accoudoirs en élastomère « soft touch ».

Types de dossier

Tous les modèles

– Dossier en bois de hêtre naturel multiplis avec rembourrage en résines expansées indéformables autoextinguibles et revêtement.
– Dossier en polypropylène moulé par injection avec finition de surface antidérapante, dans les couleurs suivantes : noir et blanc translucide.
– Dossier avec structure en tubes d'acier verni à section circulaire et revêtement en résille.

Les supports arrière du dossier sont en nylon noir dans les versions avec cadre noir et en aluminium poli dans les versions avec cadre chromé. Dans la version avec dossier en polypropylène,

le support, moulé avec le dossier, est réalisé avec la même matière.

Types de piètement

Eura Visitor

– Piètement luge.

Eura Conference

– Piètement à quatre jambes avec roulettes doubles, pivotantes et autofreinantes, en nylon pour sol souple ou avec chape en polyuréthane pour sol dur.
– Piètement à quatre jambes avec pieds en nylon renforcé.

Accessoires en option

Eura Conference

– Tablette écriteiro en polypropylène noir avec mouvement anti-panique en aluminium moulé sous pression finition polie.
– Partie sous l'assise en polypropylène moulé par injection avec crochet d'alignement rétractable en fil d'acier. **(1–3)**

DE

Materialien

Alle Modelle

– Sitz aus naturbelassenem Buchensperrholz mit Polsterung aus selbstverlöschendem, formstabilem, Kunstharzschaum. Stützrahmen aus verchromtem oder pulverbeschichtetem Stahlrohr. Armlehnen mit „Soft-Touch“-Gummierung.

Typen von Rückenlehnen

Alle Modelle

– Rückenlehne aus natürlichem Buchensperrholz mit selbstverlöschender, formstabiler Schaumstoffpolsterung und Bezug.
– Rückenlehne aus spritzgegossenem Polypropylen mit rutschfester Oberfläche, in lichtdurchlässigem Schwarz und Weiß.
– Rückenlehne mit einem Gestell aus lackierter Stahlstange und Mesh-Bezug. *Die Rückenlehnenstützen sind in den schwarzen Rahmenversionen aus schwarzem Nylon und in den verchromten Rahmenversionen aus poliertem Aluminium. Bei der Version mit Polypropylen-Rückenlehne ist die mit der Rückenlehne kaschierte Halterung aus dem gleichen Material.*

Grundmodelle

Eura Visitor

– Kufengestell.

Eura Conference

– Standfuß mit vier Beinen mit selbstbremsenden Doppel-Lenkrollen aus Nylon für weiche Böden oder mit Polyurethan-Lauflfläche für harte Böden.

– Standfuß mit vier Beinen mit verstärkten Nylonfüßen.

Sonderzubehörteile

Eura Conference

– Schreibplatte aus schwarzem Polypropylen mit Anti-Panik-Funktion aus poliertem Aluminiumdruckguss.
– Sitzunterbau aus spritzgegossenem Polypropylen mit verdeckter Reihenverbindung aus Stahldraht. **(1–3)**

ES

Materiales

Todos los modelos

– Asiento en multicapa de madera de haya natural tapizado y acolchado con resinas expandidas indeformables autoextinguibles. Estructura de soporte en tubular de acero asform cromado o pintado con polvo epoxídico. Cubiertas de los brazos de elastómero «soft touch».

Tipos de respaldo

Todos los modelos

– Respaldo en multicapa de madera de haya natural tapizada con acolchado de resinas expandidas indeformables autoextinguibles.
– Respaldo de polipropileno moldeado por inyección, superficie con acabado antideslizante, en negro y blanco translúcido.
– Respaldo con estructura de varillas de acero pintado y tapizado con malla. *Los soportes posteriores del respaldo son de nailon negro en las versiones con estructura negra y de aluminio pulido en las versiones con estructura cromada. En la versión con respaldo de polipropileno, el soporte, comoldeado con el respaldo, es del mismo material.*

Tipos de base

Eura Visitor

– Base de patín.

Eura Conference

– Base de cuatro patas con ruedas giratorias autofrenantes de doble rodadura, fabricadas en nailon para suelos blandos y con banda de poliuretano para suelos duros.
– Base de cuatro patas con pies de nailon reforzado.

Accesorios opcionales

Eura Conference

– Pala de escritura es polipropileno negro con movimiento antipánico en aluminio pulido fundido a presión.
– Reverso del asiento en polipropileno moldeado por inyección con gancho de alineación retráctil en alambre de acero. **(1–3)**



EN – Warranty IT – Garanzia
FR – Garantie DE – Garantie
ES – Garantía

Zero9 Family

Zero9 Contract



BaccoliniDesign

Zero9

Zero9 Filo

Zero9 Table



Zero9 Family

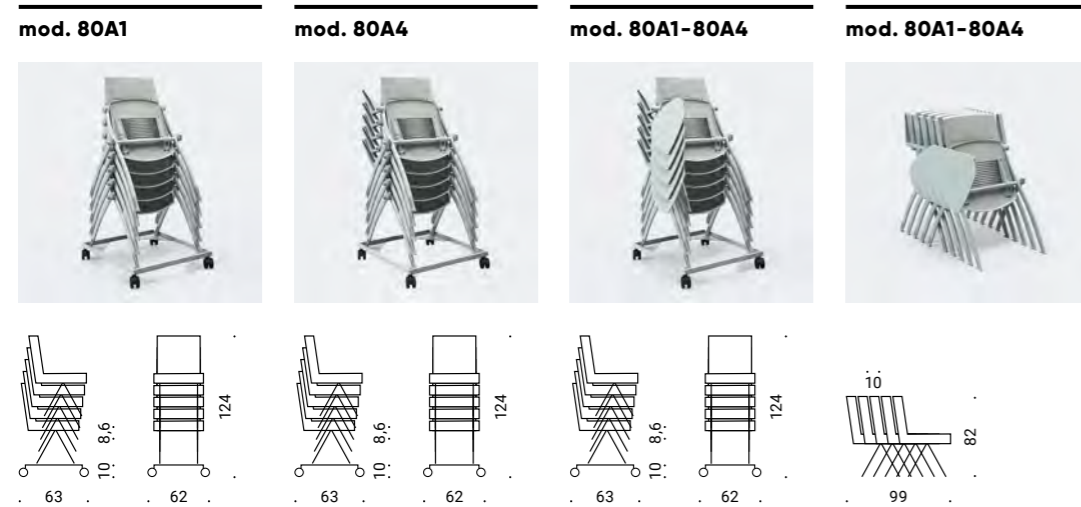
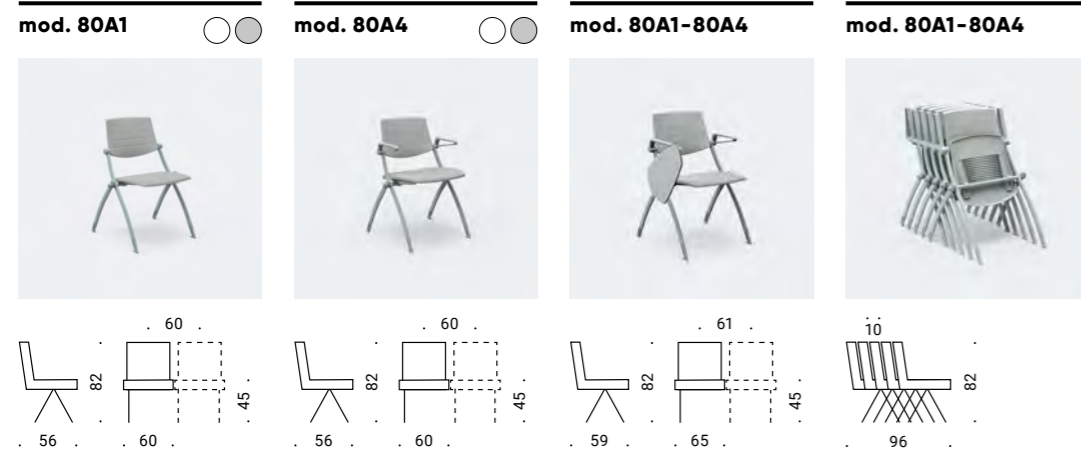

EN – Maximum 10 Zero9 with feet per cart IT – Max 10 Zero9 con piedini per carrello FR – Max 10 Zero9 avec pieds par chariot DE – Max 10 Zero9 mit Füßen für den Wagen ES – Máx. 10 Zero9 con pies por carro

EN – Frame IT – Telaio FR – Châssis DE – Gestell ES – Estructura

○ White ● Grey

EN – Combinations of seat and backrest IT – Combinazioni schienale e sedile FR – Combinaisons dossier et assise DE – Rückenlehnen-Sitzkombination ES – Combinaciones respaldo y asiento



<p>PP EN – Polypropylene IT – Polipropilene FR – Polypropylène DE – Polypropylen ES – Polipropileno</p>	<p>Upholstered EN – Upholstered IT – Tapezzato FR – Tapissée DE – Stoffbezogen ES – Tapizada</p>	<p>Wood EN – Wood IT – Legno FR – Bois DE – Holz ES – Madera</p>	<p>Mesh EN – Mesh IT – Rete FR – Résille DE – Netzgewebe ES – Malla</p>
---	--	--	---

Models



Zero9



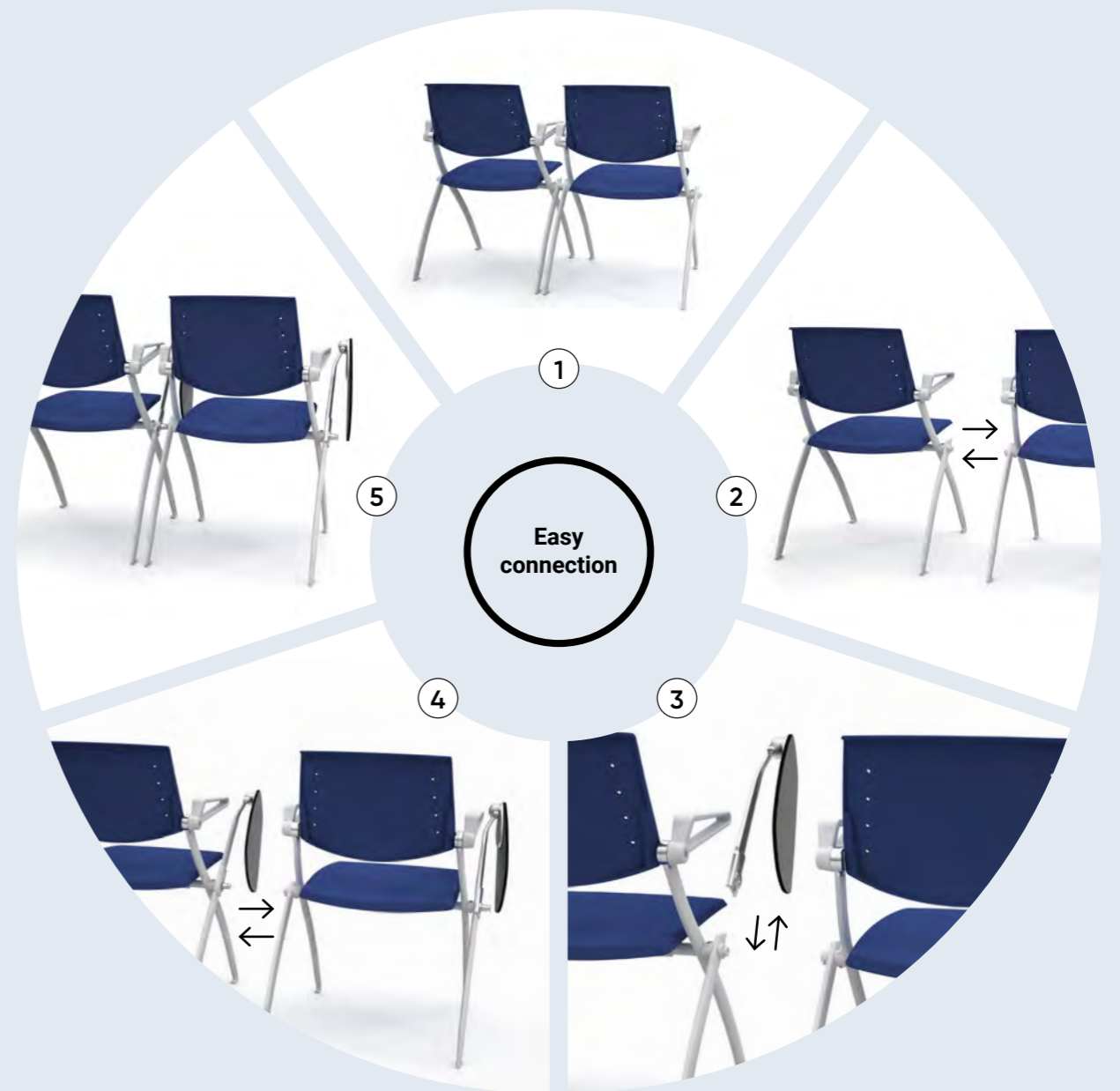



mod. 8001/V2/V3/V4-Y mod. 8005/V2/V3/V4-Y mod. 8005/V2/V3/V4-YH

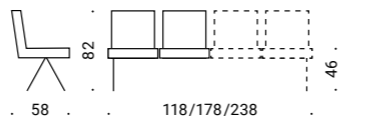
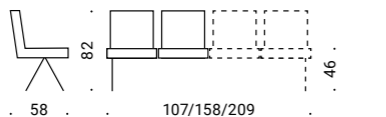
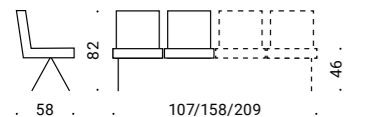

mod. 8001/V2/V3/V4-Z mod. 8005/V2/V3/V4-Z mod. 8005/V2/V3/V4-ZH

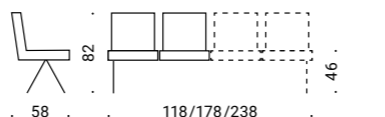
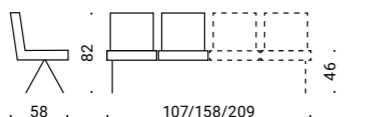
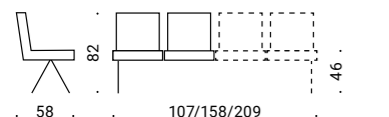

EN – Frame IT – Telaio FR – Châssis DE – Gestell ES – Estructura

White Grey

EN – Combinations of seat and backrest IT – Combinazioni schienale e sedile FR – Combinaisons dossier et assise DE – Rückenlehnen-Sitzkombination ES – Combinaciones respaldo y asiento

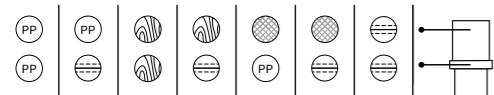

PP EN – Polypropylene
IT – Polipropilene
FR – Polypropylène
DE – Polypropylen
ES – Polipropileno

EN – Upholstered
IT – Tapezzato
FR – Tapissée
DE – Stoffbezogen
ES – Tapizada

EN – Wood
IT – Legno
FR – Bois
DE – Holz
ES – Madera

EN – Mesh
IT – Rete
FR – Résille
DE – Netzgewebe
ES – Malla

Models



Zero9 Contract





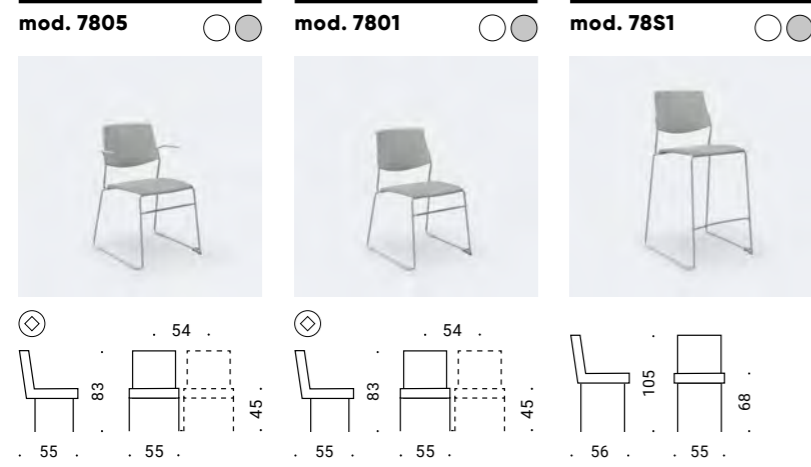

Models

EN – Frame IT – Telaio FR – Châssis DE – Gestell ES – Estructura

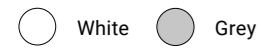

EN – Combinations of seat and backrest IT – Combinazioni schienale e sedile FR – Combinaisons dossier et assise DE – Rückenlehnen-Sitzkombination ES – Combinaciones respaldo y asiento

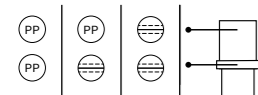

PP EN – Polypropylene
IT – Polipropilene
FR – Polypropylène
DE – Polypropylen
ES – Polipropileno

Upholstered EN – Upholstered
IT – Tapezzato
FR – Tapissée
DE – Stoffbezogen
ES – Tapizada

Tablet EN – Tablet
IT – Tavoletta
FR – Tablette
DE – Schreibplatte
ES – Pala

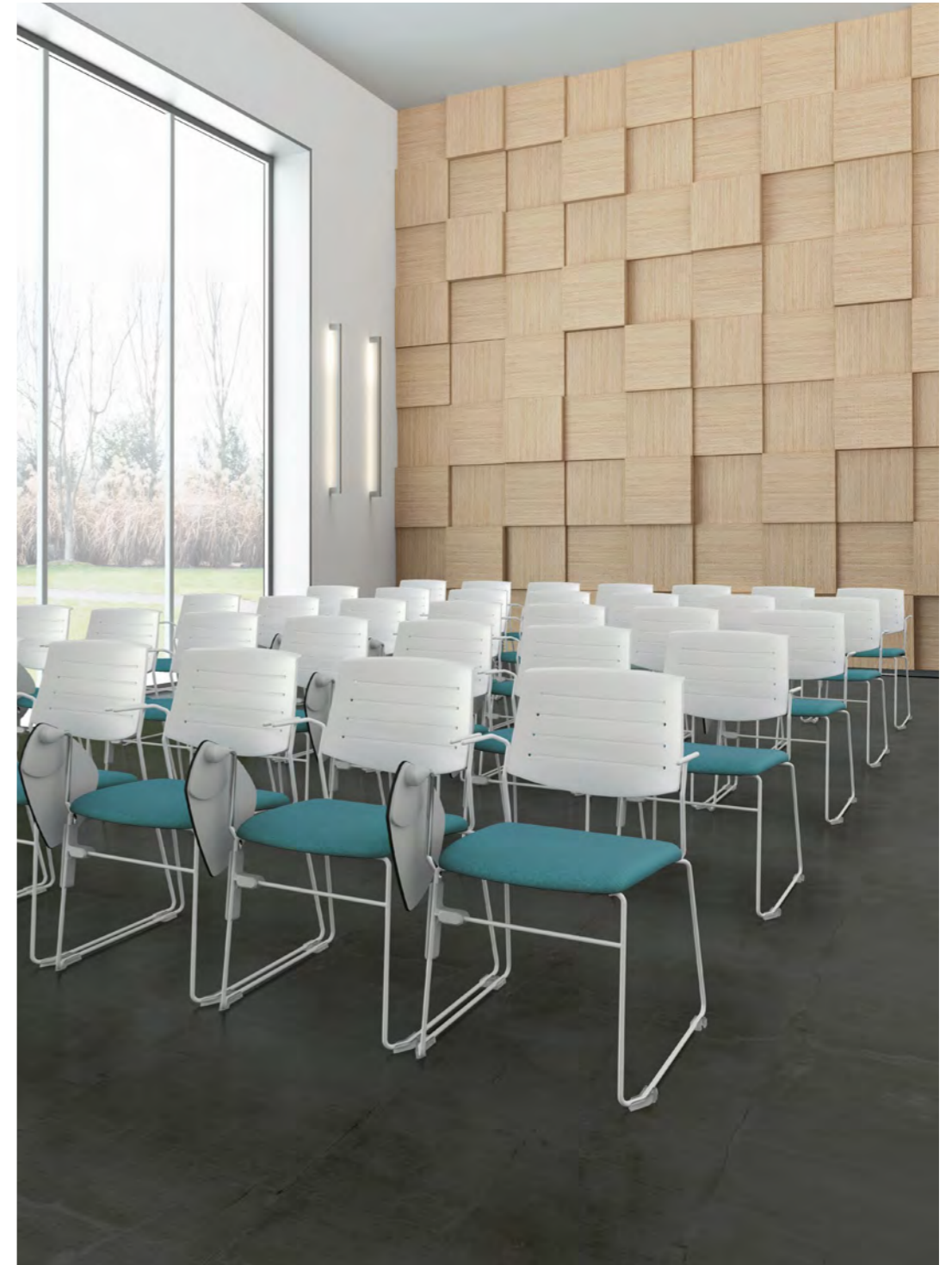

Zero9 Filo



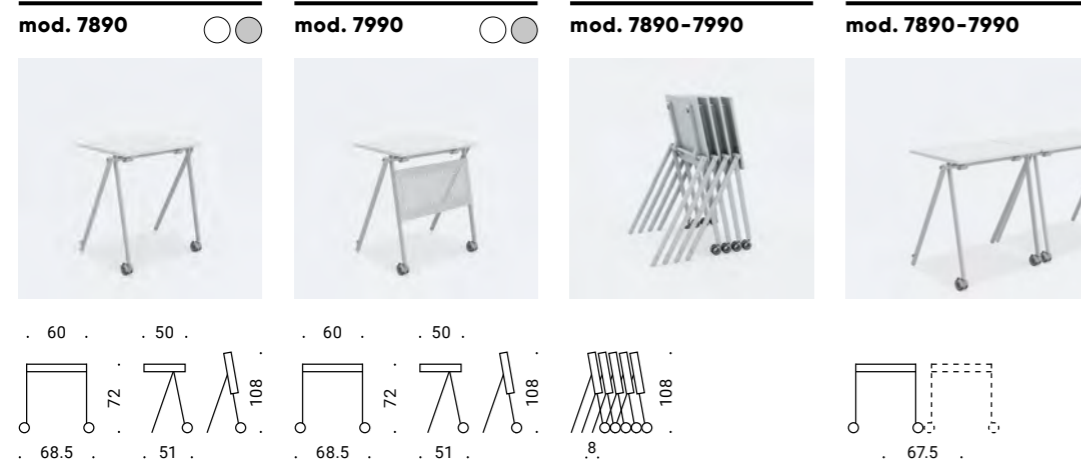

Models

EN – Frame IT – Telaio FR – Châssis DE – Gestell ES – Estructura

○ White ● Grey

EN – All models with top in white or natural beech plywood
 IT – Tutti i modelli con piano in laminato bianco o faggio naturale
 FR – Tous les modèles avec table en stratifié blanc ou en hêtre naturel
 DE – Alle Modelle mit Schreibplatte mit Laminatbeschichtung, Farbe weiß oder Naturbuche
 ES – Todos los modelos con superficie en laminado blanco o haya natural



Zero9 Table



Zero9 Table



EN

Materials*Zero9, Zero9 Contract*

– Seat and backrest in scratch resistant polypropylene in various colours (some self-extinguishing colours available).

– Seat and backrest in scratch resistant polypropylene with panel padded with self-extinguishing shape-retaining flexible polyurethane.

– Seat and backrest in varnished natural beech plywood (also self-extinguishing), available on design in various stains and finishes.

– Backrest formed with black nylon frame covered with polyester mesh.

Zero9 Filo

– Seat and backrest in scratch resistant polypropylene in various colours (some colours available self-extinguishing), or upholstered panel.

Zero9 Table

– Writing tablet surfaced with plywood in natural beech colour or white with scratch resistant finish and edging in ABS.

Base types*Zero9, Zero9 Table*

– Oval tubular steel frame, with feet or self-braking swivel castors and nylon alignment coupling. **(1)**

Zero9 Contract

– Seat supports and backrest in steel plate, supporting cross-member in rectangular steel section, folding legs in steel plate with nylon feet, or fixed leg. **(4–5)**

Zero9 Filo

– Steel rod frame.

Optional accessories*Zero9*

– Manual fold-away armrests in fibreglass reinforced polypropylene.

– Anti-panic removable writing tablet in HPL with die-cast polished aluminium frame. **(3)**

Zero9 Contract

– Fixed armrests in steel with top in polypropylene.

– Anti-panic removable writing tablet in HPL. **(2)**

– Seating side table surfaced in natural beech plywood or white with scratch resistant finish and edging in ABS.

Zero9 Filo

– Armrests in steel rod.

– Anti-panic writing tablet with rapid coupling-uncoupling mechanism.

Zero9 Table

– Front panel in perforated steel plate.

For all models

– The metal frames are coated grey or white as standard. The details and armrests in polypropylene are grey or white as standard. **(1)**

IT

Materiali*Zero9, Zero9 Contract*

– Sedile e schienale in polipropilene antigraffio di vari colori (alcuni colori disponibili autoestinguenti).
– Sedile e schienale in polipropilene antigraffio con pannello imbottito con poliuretano flessibile indeformabile e autoestinguente.

– Sedile e schienale in multistrato di faggio verniciato al naturale (anche autoestinguente), disponibile su progetto in varie essenze e finiture.
– Schienale realizzato con telaio in nylon nero e rivestito con rete in poliester.

Zero9 Filo

– Sedile e schienale in polipropilene antigraffio di vari colori (alcuni colori disponibili autoestinguenti) o pannello riportato tappezzato.

Zero9 Table

– Piano di scrittura rivestito in laminato color faggio naturale o bianco con finitura antigraffio e bordo perimetrale in ABS.

Base*Zero9, Zero9 Table*

– Struttura in tubolare ellissoidale d'acciaio, con piedini o ruote piroettanti autofrenanti e aggancio di allineamento in nylon. **(1)**

Zero9 Contract

– Supporti del sedile e dello schienale in lamiera d'acciaio, trave portante in tubolare rettangolare d'acciaio, gambe mobili in lamiera d'acciaio con piedini in nylon o gamba fissa. **(4–5)**

Zero9 Filo

– Struttura in tondino d'acciaio.

Accessori opzionali*Zero9*

– Braccioli ribaltabili manualmente in polipropilene caricato fibra di vetro.

– Tavoletta di scrittura antipanico e rimovibile in HPL con struttura in alluminio pressofuso lucidato. **(3)**

Zero9 Contract

– Braccioli fissi in acciaio con top in polipropilene.

– Tavoletta di scrittura antipanico in HPL. **(2)**

– Tavolino interposto rivestito in laminato color faggio naturale o bianco con finitura antigraffio

e bordo perimetrale in ABS.

Zero9 Filo

– Braccioli in tondino d'acciaio.

– Tavoletta di scrittura con movimento antipanico con dispositivo di aggancio / sgancio rapido.

Zero9 Table

– Pannello frontale in lamiera d'acciaio forata.

Per tutti i modelli

– Le strutture metalliche sono di serie verniciate grigio o bianco; i particolari e i braccioli in polipropilene sono di serie nei colori grigio o bianco. **(1)**

FR

Matériaux*Zero9, Zero9 Contract*

– Assise et dossier en polypropylène anti-rayures de différents coloris (certains coloris sont disponibles en version autoextinguible).

– Assise et dossier en polypropylène anti-rayures avec panneau rembourré en polyuréthane flexible indéformable et autoextinguible.

– Assise et dossier en bois de hêtre multiplis vernis au naturel (y compris en version autoextinguible), disponible sur projet dans différentes essences et finitions.

– Dossier réalisé avec cadre en nylon noir et revêtu de résille en polyester.

Zero9 Filo

– Assise et dossier en polypropylène anti-rayures de différents coloris (certains coloris sont disponibles en version autoextinguible) ou panneau tapissé.

Zero9 Table

– Petit bureau revêtu en mélaminé couleur hêtre naturel ou blanc avec finition anti-rayures et périmètre en ABS.

Types de piètement*Zero9, Zero9 Table*

– Structure en tubes d'acier à section elliptique, avec pieds ou roulettes pivotantes autofreinantes et crochet d'alignement en nylon. **(1)**

Zero9 Contract

– Supports de l'assise et du dossier en tôle d'acier, poutre portante en tubes d'acier à section rectangulaire, jambes mobiles en tôle d'acier avec pieds en nylon ou jambe fixe. **(4–5)**

Zero9 Filo

– Structure en tubes d'acier à section circulaire.

Accessoires en option*Zero9*

– Accoudoirs rabattables

manuellement en polypropylène renforcé de fibres de verre.

– Tablette écritoire anti-panique escamotable en HPL avec structure en aluminium moulé sous pression finition polie. **(3)**

Zero9 Contract

– Accoudoirs fixes en acier avec manchette en polypropylène.

– Tablette écriteoire anti-panique en HPL. **(2)**

– Tablette interposée revêtue en mélaminé couleur hêtre naturel ou blanc avec finition anti-rayures et périmètre en ABS.

Zero9 Filo

– Accoudoirs en tubes d'acier à section circulaire.

– Tablette anti-panique avec mécanisme d'accrochage / décrochage rapide.

Zero9 Table

– Panneau frontal en tôle d'acier perforée.

Pour tous les modèles

– Les structures métalliques de série sont proposées peintes de couleur grise ou blanche; les détails et les accoudoirs en polypropylène de série sont proposés en couleur grise ou blanche. **(1)**

DE

Materialien*Zero9, Zero9 Contract*

– Sitz und Rückenlehne aus kratzfestem Polypropylen in verschiedenen Farben (einige Farben sind selbstverlöschend erhältlich).

– Sitz und Rückenlehne aus kratzfestem Polypropylen mit flexibler, formstabiler, selbstverlöschender Polyurethan-Polsterung.

– Sitz und Rückenlehne aus Buchensperrholz, naturlackiert (auch selbstverlöschend), auf Wunsch in verschiedenen Hölzern und Oberflächen erhältlich.

– Rückenlehne mit schwarzem Nylonrahmen und einem Bezug aus Polyester-Netzgewebe.

Zero9 Filo

– Sitz und Rückenlehne aus kratzfestem Polypropylen in verschiedenen Farben (einige Farben sind selbstverlöschend erhältlich) oder mit gepolstertem Paneel.

Zero9 Table

– Schreibfläche laminatbeschichtet in Buche naturbelassen oder weiß mit kratzester Oberfläche und Abschlusskante aus ABS.

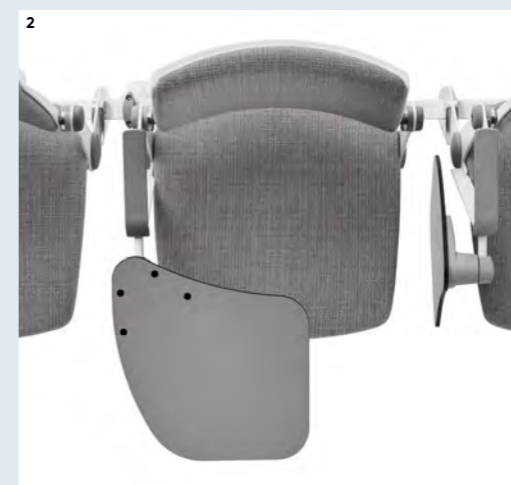
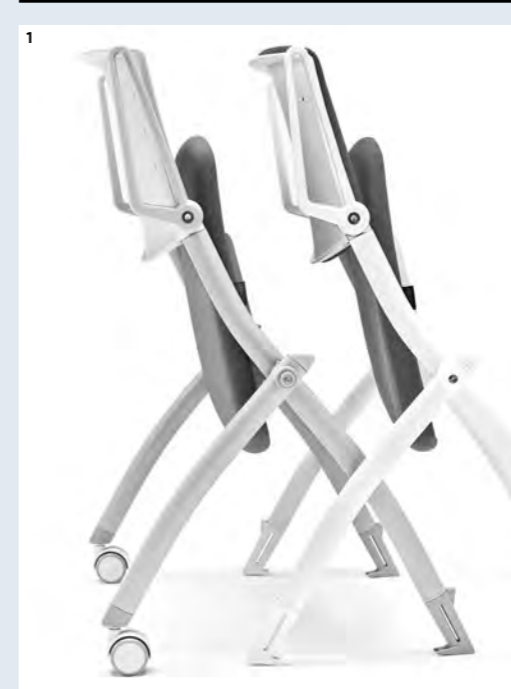

Grundmodelle

Zero9, Zero9 Table

– Ellipsenförmige Stahlrohrkonstruktion, mit Füßen oder selbstbremsenden Lenkrollen und Ausrichtungshaken aus Nylon. **(1)**

Zero9 Contract

– Sitz- und Rückenlehnenstützen aus Stahlblech, Tragbalken aus Vierkantrohr, bewegliche Beine aus Stahlblech mit Füßen aus Nylon oder festem Fuß. **(4–5)**

Zero9 Filo

– Stabstahlkonstruktion.

Sonderzubehörteile

Zero9

– Manuell klappbare Armlehnen aus glasfaserverstärktem Polypropylen.
– Abnehmbares Anti-Panik-Schreibpult in HPL mit polierter Aluminiumdruckgussstruktur. **(3)**

Zero9 Contract

– Feste Armlehnen aus Stahl mit Polypropylen-Oberfläche.
– Anti-Panik-Schreibpult aus HPL. **(2)**
– Zwischentisch laminatbeschichtet in Buche naturbelassen oder weiß mit kratzfester Oberfläche und Abschlusskante aus ABS.

Zero9 Filo

– Armlehnen aus Stahlrohr.
– Anti-Panik-Tafel aus HPL mit abgerundeten Kanten in Aluminiumgrau.

Zero9 Table

– Frontblende aus perforiertem Stahlblech.

Bei allen Modellen

– Sind die Metallkonstruktionen standardmäßig grau oder weiß lackiert, die Details und die Armlehnen aus Polypropylen sind standardmäßig grau oder weiß. **(1)**

ES

Materiales

Zero9, Zero9 Contract

– Asiento y respaldo de polipropileno resistente a los arañazos, disponible en varios colores (algunos de ellos autoextinguibles) o tapizados.
– Asiento y respaldo de polipropileno resistente a los arañazos con tablero acolchado en poliuretano flexible indeformable y autoextinguible.
– Asiento y respaldo en multicapa de haya barnizada al natural (también autoextinguible), disponible según el proyecto en diferentes modelos y acabados.
– Respaldo con estructura de nailon negro y tapizado con malla de poliéster.

Zero9 Filo

– Asiento y respaldo de polipropileno resistente a los arañazos, disponible en varios colores (algunos de ellos autoextinguibles) o panel tapizado.

Zero9 Table

– Plano de escritura chapado en laminado color haya natural o blanco con acabado resistente a los arañazos y borde perimetral de ABS.

Tipos de base

Zero9, Zero9 Table

– Estructura en tubular elipsoidal de acero, con pies o ruedas giratorias autofrenantes y enganche de alineación de nailon. **(1)**

Zero9 Contract

– Soportes del asiento y del respaldo de chapa de acero, viga portante rectangular de acero, patas móviles de chapa de acero con pies de nailon o pata fija. **(4–5)**

Zero9 Filo

– Estructura en varilla de acero.

Accesorios opcionales

Zero9

– Brazos abatibles manualmente de polipropileno reforzado con fibra de vidrio.
– Pala de escritura antipánico abatible de HPL. **(3)**

Zero9 Contract

– Brazos fijos de acero con parte superior de polipropileno.
– Pala de escritura antipánico de HPL con articulación de aluminio pulido fundido a presión. **(2)**
– Mesita intercalada chapada en laminado color haya natural o blanco con acabado resistente a los arañazos y borde perimetral de ABS.

Zero9 Filo

– Brazos en varilla de acero.
– Pala de escritura antipánico con dispositivo de enganche / desenganche rápido.

Zero9 Table

– Panel frontal de chapa de acero perforada.

Para todos los modelos

– Las estructuras metálicas vienen pintadas de serie en gris o blanco; los detalles y los brazos de polipropileno vienen pintados de serie en gris o blanco. **(1)**



EN – Polypropylene colours
IT – Cartella colori polipropilene
FR – Coloris polypropylène
DE – Farbtafel für Polypropylen
ES – Colores polipropileno



EN – Warranty IT – Garanzia
FR – Garantie DE – Garantie
ES – Garantía

Woody



BaccoliniDesign



Woody

mod. 601S LL

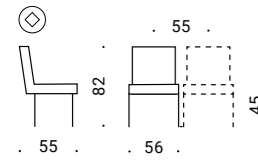

mod. 601S PL

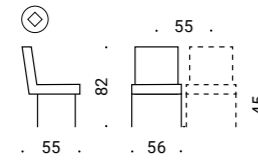

mod. 601S TT

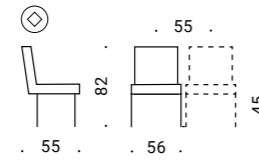

mod. 605S LL

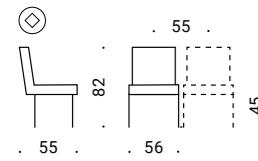

mod. 605S PL

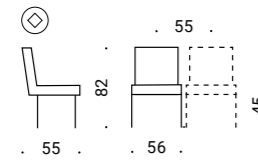

mod. 605S TT

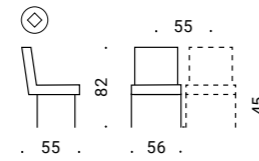

mod. 601C LL

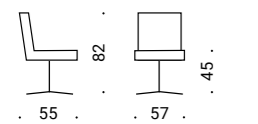
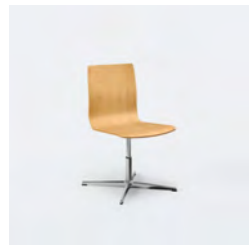

mod. 601C PL

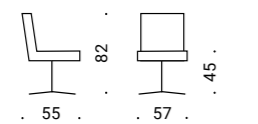
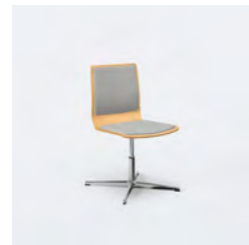

mod. 601C TT

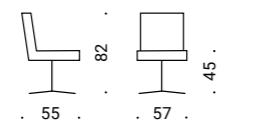

- ◇ EN – Tablet
- IT – Tavoletta
- FR – Tablette
- DE – Schreibplatte
- ES – Pala

Models



Woody





Multipurpose

Woody

mod. 901/V2/V3/V4 LL

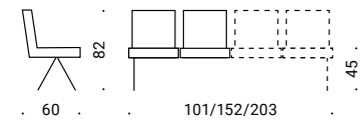

mod. 901/V2/V3/V4 PL

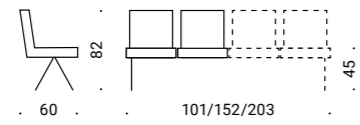

mod. 901/V2/V3/V4 TT

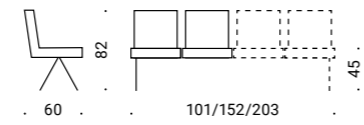

Models



EN

Materials*All models*

- Moulding in uncovered varnished natural beech plywood.
- Moulding in natural beech plywood, completely padded and upholstered.
- Moulding in uncovered natural beech plywood with padded and upholstered panels.
- Always with padding in self-extinguishing shape-retaining synthetic foam.*

Base types*All models*

- Cross-member in black coated steel with self-supporting feet in contact with floor.
- Sled base in chromed steel rod with nylon feet.
- Trestle base in chromed steel rod with nylon feet. **(4)**

Optional accessories*Woody with sled base*

- Armrests in steel rod.
- Anti-panic writing tablet with rapid coupling-uncoupling mechanism. **(1-3)**

IT

Materiali*Tutti i modelli*

- Monoscocca in legno multistrato di faggio naturale a vista verniciato.
- Monoscocca in legno multistrato di faggio naturale completamente imbottita e rivestita.
- Monoscocca in legno multistrato di faggio naturale a vista con pannelli imbottiti e rivestiti.
- Sempre con imbottitura in resine espanse indeformabili autoestinguenti.*

Tipologie di base*Tutti i modelli*

- Trave d'acciaio verniciata nera con piedi autoportanti in appoggio al pavimento.
- Base a slitta in tondino d'acciaio cromato con piedini in nylon.
- Base a trespolo in tondino d'acciaio cromato con piedini in nylon. **(4)**

Accessori opzionali*Woody su slitta*

- Braccioli in tondino d'acciaio.
- Tavoletta di scrittura con movimento antipanic con dispositivo di aggancio / sgancio rapido. **(1-3)**

FR

Matériaux*Tous les modèles*

- Monocoque en bois de hêtre naturel multiplis apparent verni.
- Monocoque en bois de hêtre naturel multiplis complètement rembourrée et revêtue.

- Monocoque en bois de hêtre naturel multiplis apparent avec panneaux rembourrés et revêtus.
- Toujours avec rembourrage en résines expansées indéformables autoextinguibles.*

Types de piètement*Tous les modèles*

- Poutre en acier verni noir avec pieds autoportants en appui sur le sol.
- Piètement luge en tubes d'acier chromé à section circulaire avec pieds en nylon.
- Piètement central en tubes d'acier chromé à section circulaire avec pieds en nylon. **(4)**

Accessoires en option*Woody avec piètement luge*

- Accoudoirs en tubes d'acier à section circulaire.
- Tablette anti-panique avec mécanisme d'accrochage / décrochage rapide. **(1-3)**

DE

Materialien*Alle Modelle*

- Einzelschale aus Buchensperrholz mit naturbelassener Lackierung.
- Einzelschale aus Buchensperrholz, komplett gepolstert und bezogen.
- Einzelschale aus Buchensperrholz, naturbelassen mit gepolsterten und überzogenen Paneelen.
- Immer mit selbstverlöschender, formstabiler Schaumstoffpolsterung.*

Grundmodelle*Alle Modelle*

- Schwarz lackierter Stahlträger mit selbsttragenden Füßen zum Aufstellen auf dem Boden.
- Kufengestell aus verchromtem Rundstahl mit Nylonfüßen.
- Grundrahmen aus verchromtem Rundstahl mit Nylonfüßen. **(4)**

Sonderzubehörteile*Woody mit Kufengestell*

- Anti-Panik-Tafel aus HPL mit abgerundeten Kanten in Aluminiumgrau. **(1-3)**

ES

Materiales*Todos los modelos*

- Monocasco en multicapa de haya natural vista pintada.
- Monocasco en multicapa de haya natural completamente acolchado y tapizado.
- Monocasco en multicapa de haya natural vista con paneles acolchados y tapizados.
- Siempre con acolchado de resinas expandidas indeformables autoextinguibles.*

Tipos de base*Todos los modelos*

- Viga de acero pintada de color negro con pies autoportantes apoyados sobre el suelo.
- Base de patín en varilla de acero cromado con pies de nailon.
- Base en trípode de acero cromado con pies de nailon. **(4)**

Accesorios opcionales*Woody con base de patin*

- Brazos en varilla de acero.
- Pala de escritura antipánico con dispositivo de enganche / desenganche rápido. **(1-3)**

4



EN – Warranty IT – Garanzia
FR – Garantie DE – Garantie
ES – Garantía

EN

Woody with removable tablet

- Place the tablet support behind the front leg. **(1)**
- Fasten the support to the leg. **(2)**
- Press downwards to fix the tablet. **(3)**

IT

Woody con tavoletta removibile

- Posiziona il supporto tavoletta dietro la gamba anteriore. **(1)**
- Aggancia il supporto alla gamba. **(2)**
- Fai pressione verso il basso per fissare la tavoletta. **(3)**

FR

Woody avec tablette amovible

- Positionner le support de la tablette derrière la jambe antérieure. **(1)**
- Accrocher le support à la jambe. **(2)**
- Faire pression vers le bas pour fixer la tablette. **(3)**

DE

Woody mit Abnehmbare Schreibpult

- Platzieren des Tischhalters hinter dem Vorderbein. **(1)**
- Einhängen der Stütze an das Bein. **(2)**
- Zum Sichern des Tisches nach unten drücken. **(3)**

ES

Woody con Pala de escritura removable

- Coloca el soporte de la pala detrás de la pata delantera. **(1)**
- Engancha el soporte a la pata. **(2)**
- Presiona hacia abajo para encajar la pala. **(3)**

1

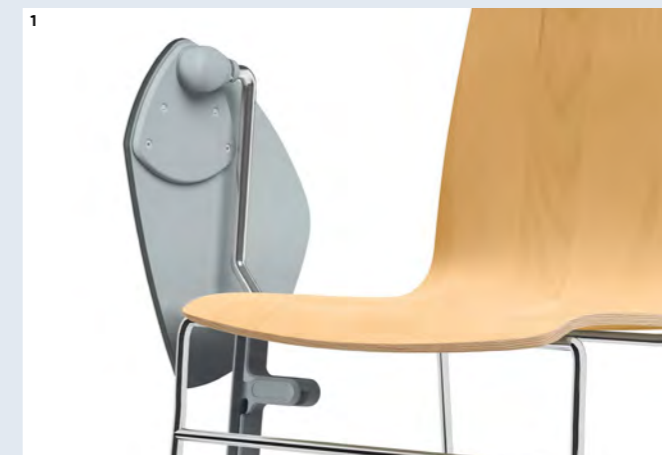

2

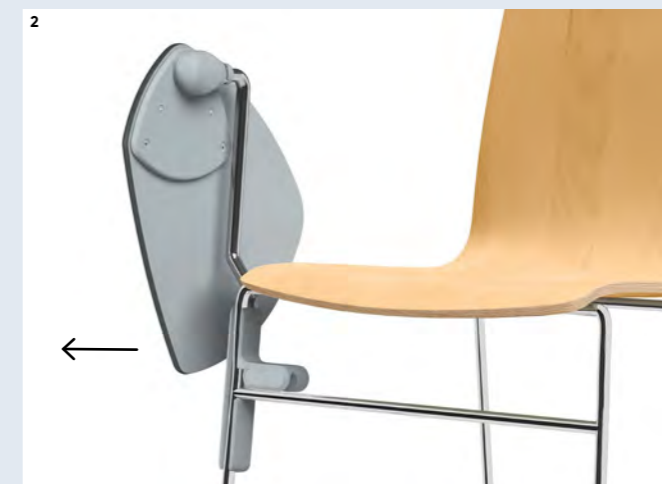

3



Omnia Contract

BaccoliniDesign



Omnia Contract

mod. 4205R mod. 4205R mod. 4201R mod. 4201B

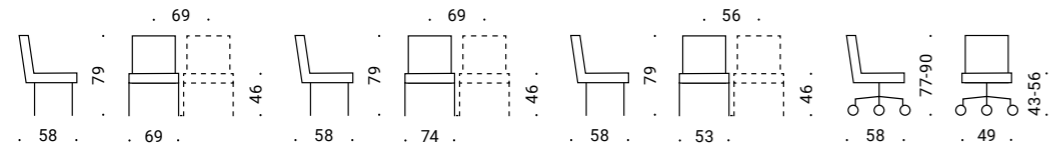

mod. 4205/V2/V3/V4 YV mod. 4205/V2/V3/V4 YQ mod. 4201/V2/V3/V4 YN

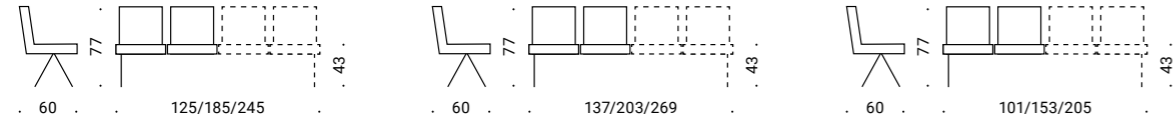

mod. 4205/V2/V3/V4 ZV mod. 4205/V2/V3/V4 ZQ mod. 4201/V2/V3/V4 ZN

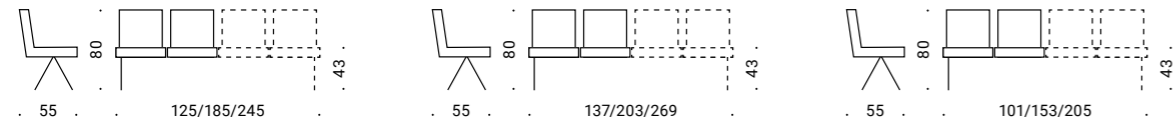

Models



Omnia Contract



**EN****Materials**

– Seat and backrest in varnished natural beech plywood or padded and upholstered, tubular steel frame. Any padding in shape-retaining synthetic foam.

Base types

– Four-leg base in tubular steel.
– Five-spoke base in nylon with castors or fixed feet. The self-braking swivel castors are in nylon for soft flooring or with polyurethane tread for hard flooring. The fixed feet are in nylon.
– Base on supporting cross-member in rectangular steel section, with leg and foot in welded oval steel tube and nylon feet.

Mechanisms

Only in the swivel version
– Seat height adjustment with gas cylinder.

Optional accessories

– Armrests in injection moulded polypropylene with steel frame.
– Writing tablet in HPL with black rounded edging with anti-panic mechanism in reinforced nylon.
– Side table for waiting bench in black laminated particle board with rubber edging.
– Document basket in arc-welded steel wire.

IT**Materiali**

– Sedile e schienale in legno multistrato di faggio naturale verniciato oppure imbottito e tappezzato, telaio in tubolare d'acciaio. Eventuale imbottitura in resine espanse indeformabili.

Tipologie di base

– Base a quattro gambe in tubolare d'acciaio.
– Base a cinque razze in nylon con ruote o piedini fissi. Le ruote piroettanti autofrenanti sono in nylon per suolo morbido o con battistrada in poliuretano per suolo duro. I piedini fissi sono in nylon.
– Base su trave portante in tubolare rettangolare d'acciaio, con gamba e piede in tubolare ovale d'acciaio saldata e piedini in nylon.

Meccanismi

Solo nella versione girevole
– Regolazione in altezza della seduta con colonna a gas.

Accessori opzionali

– Braccioli in polipropilene stampato a iniezione con struttura in acciaio.
– Tavoleta scrittoio in HPL con bordi arrotondati di colore nero con movimento antipánico in nylon rinforzato.
– Tavolino per panchetta d'attesa in conglomerato ligneo laminato nero con bordo in gomma.
– Cesto portadocumenti in filo d'acciaio elettrosaldato.

FR**Matériaux**

– Assise et dossier en bois de hêtre naturel multiplis vernis ou rembourré et tapissé, cadre en tubes d'acier. Rembourrage éventuel en résines expansées indéformables.

Types de piètement

– Piètement à quatre jambes en tubes d'acier.
– Piètement à cinq branches en nylon avec roulettes ou pieds fixes. Les roulettes pivotantes autofreinantes sont en nylon pour sol souple ou avec chape en polyuréthane pour sol dur. Les pieds fixes sont en nylon.
– Piètement sur poutre portante en tubes d'acier à section rectangulaire, avec jambe et pied en tubes d'acier à section ovale soudés et pieds en nylon.

Mécanismes

Uniquement dans la version pivotante
– Réglage en hauteur du siège avec vérin à gaz.

Accessoires en option

– Accoudoirs en polypropylène moulé par injection avec structure en acier.
– Tablette écrite en HPL avec bords arrondis de couleur noire avec mouvement anti-panique en nylon renforcé.
– Tablette pour banquette d'attente en bois aggloméré mélaminé noir avec bord en caoutchouc.
– Panier porte-documents en fil d'acier électrosoudé.

DE**Materialien**

– Sitz und Rückenlehne aus naturlackiertem oder gepolstertem und bezogenem Buchensperrholz, Stahlrohrrahmen. Mögliche Polsterung aus nicht formstabilen Schaumstoffen.

Grundmodelle

– Standfuß mit vier Beinen aus Stahlrohr.
– Fünfarmiges Fußkreuz aus Nylon mit Rollen oder festen Standfüßen. Die selbstbremsenden Lenkrollen bestehen für weiche Böden aus Nylon und sind für harte Böden mit einer Polyurethan-Lauffläche ausgestattet. Die Standfüße sind aus Nylon gefertigt.
– Sockel auf Stützbalken aus Vierkantröhrenstahl, mit Bein und Fuß aus geschweißtem Ovalrohrstahl und Füßen aus Nylon.

Funktionen

Nur in der drehbaren Ausführung
– Sitzhöhenverstellung mit Gasdruckfeder.

Sonderzubehörteile

– Armlehnen aus Polypropylen im Spritzgussverfahren mit Stahlkonstruktion.
– Schreibplatte aus HPL mit schwarzen abgerundeten Kanten, mit Anti-Panik-Funktion aus verstärktem Nylon.
– Beistelltisch für Wartebänke aus schwarz laminiertem Schichtholz mit Gummikante.
– Ablagekorb für Dokumente aus geschweißtem Stahldraht.

ES**Materiales**

– Asiento y respaldo en multicapa de haya natural pintada o acolchada y tapizada, estructura en tubular de acero. Acolchado de resinas expandidas indeformables opcional.

Tipos de base

– Base de cuatro patas en tubular de acero.
– Base de cinco radios de nailon con ruedas o pies fijos. Las ruedas, giratorias y autofrenantes, están fabricadas en nailon para suelos blandos y con banda de poliuretano para suelos duros. Los pies fijos son de nailon.
– Base sobre viga portante en tubular rectangular de acero, con patas y pies en tubular ovalado soldado y pies de nailon.

Mecanismos

Solo en la versión giratoria
– Altura del asiento regulable con pistón a gas.

Accesorios opcionales

– Brazos de polipropileno moldeado por inyección con estructura de acero.
– Pala de escritura de HPL con bordes redondeados de color negro de nailon reforzado con movimiento antipánico.
– Mesita para bancada de espera en aglomerado de madera laminada negra con borde de goma.
– Cesta portadocumentos de alambre de acero electrosoldado.



EN – Warranty **IT – Garanzia**
FR – Garantie **DE – Garantie**
ES – Garantía

Hip-Up Family

Hip-Up



Hip-Up T



Hip-Up T-matic



mod. 3190 Hip-Up

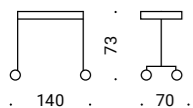

mod. 3180 Hip-Up T

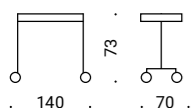

mod. 3170 Hip-Up T-matic

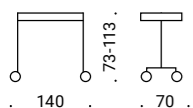

Models



Hip-Up Family

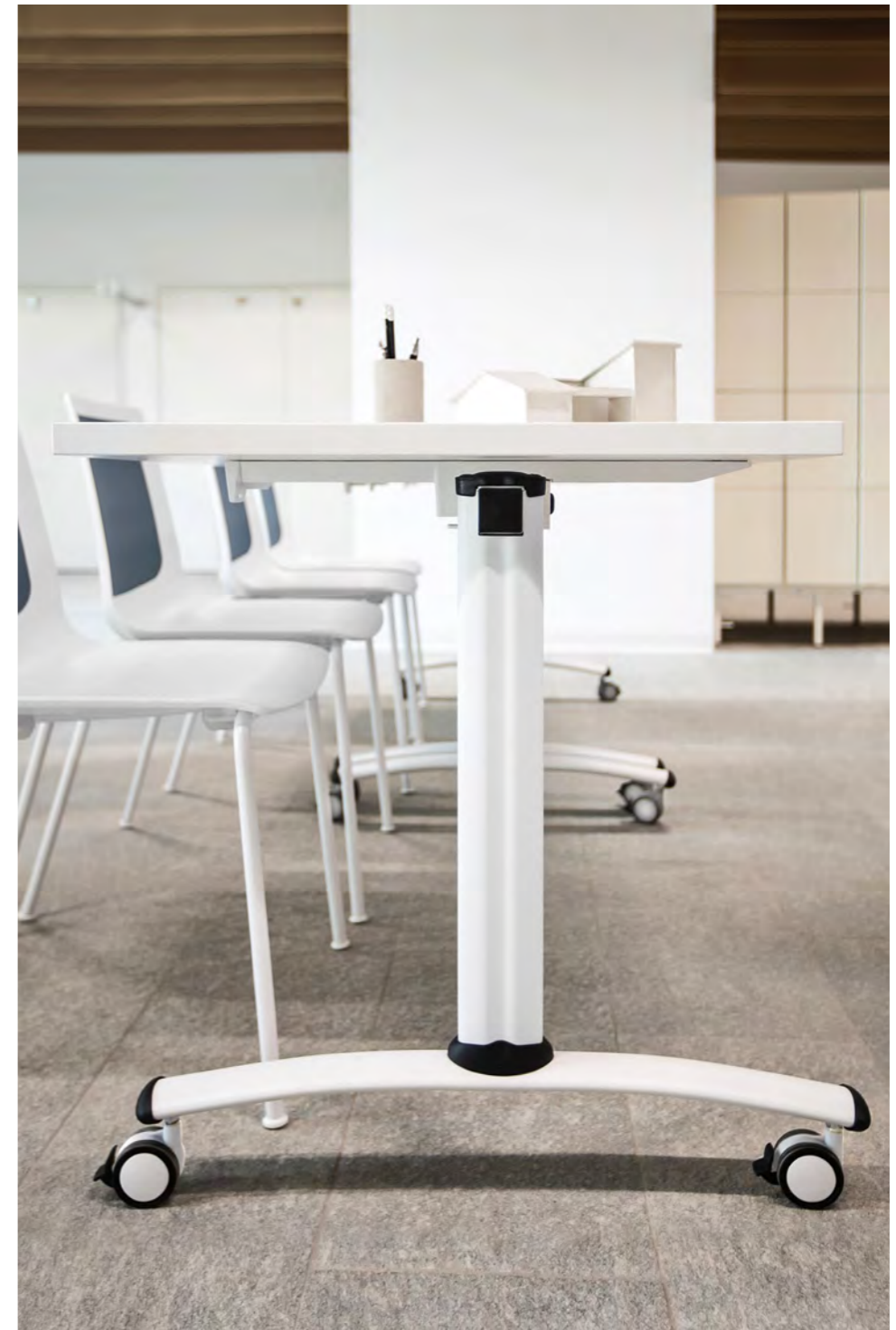







EN – Modules
 IT – Moduli
 FR – Modules
 DE – Module
 ES – Módulos

EN – Arrangement types
 IT – Tipologie di composizione
 FR – Types de composition
 DE – Art der Zusammenstellung
 ES – Tipos de composición

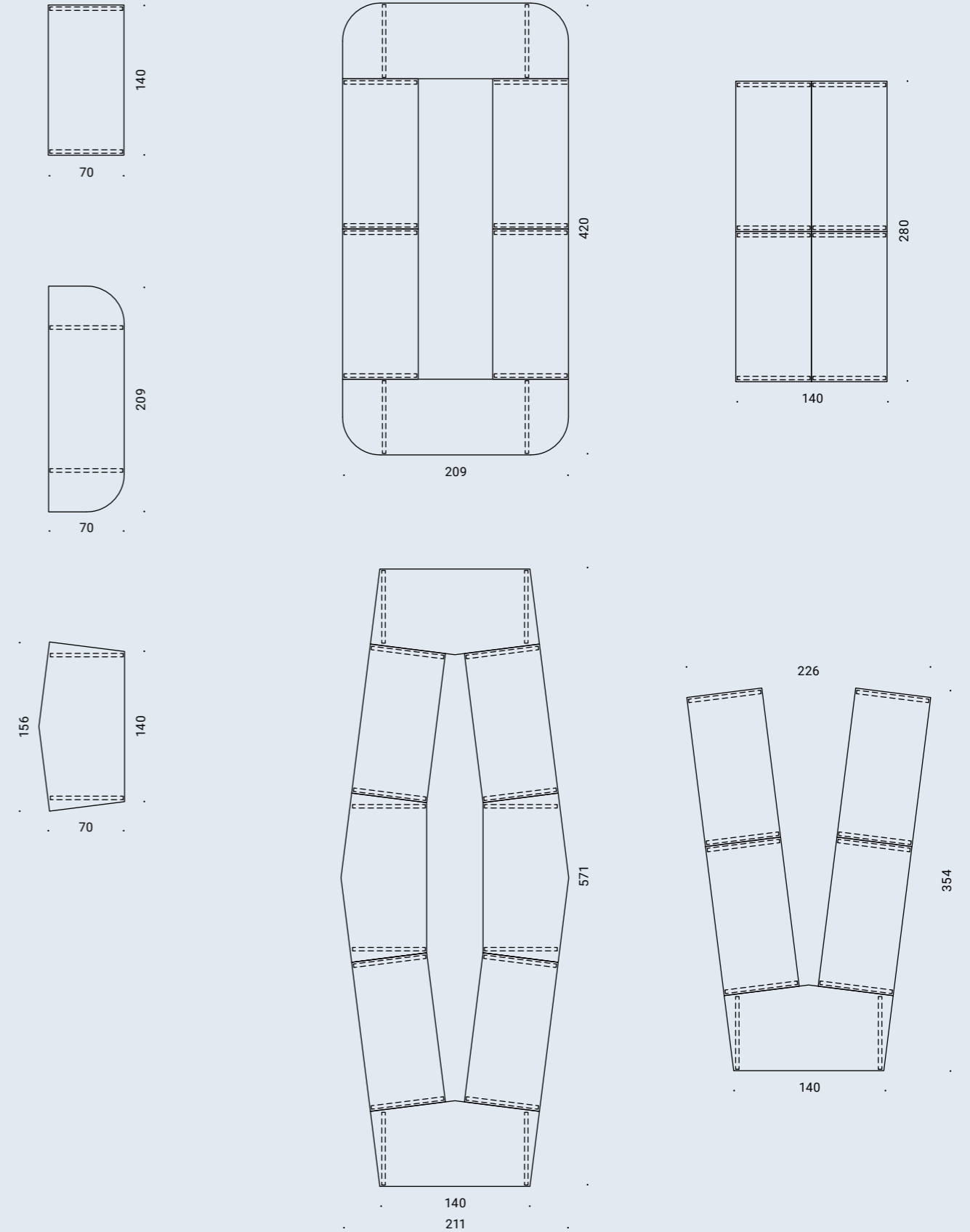

EN

Materials

All models

– Table top in double laminated particle board with scratch resistant finish and edging in ABS, thickness 30 mm.

Hip-Up

– Base in steel tubing with square cross-section, with support structure in sheet metal. White-varnished leg in elliptical steel tubing with cover caps in black polypropylene.

Hip-Up T

– Base in steel tubing with rectangular cross-section, with support structure in bent and varnished sheet metal. White-varnished leg in rectangular steel tubing with cover caps in black polypropylene.

Hip-Up T-matic

– Base in bent and varnished steel sheet metal. White varnished leg in square steel tubing with cover caps in sheet metal.

Base types

All models

– Swivel castors with pedal lock system, double wheel gauge and polyurethane tread.

Mechanisms

Hip-Up

– System for tilting the drawn steel seat, with spring hooking and release by means of dedicated polypropylene levers.

Hip-Up T and Hip-Up T-matic

– System for tilting the drawn steel shelf with spring coupling and release by means of special levers in polypropylene and plane adjustment of the seat.

Hip-Up T-matic

– Integrated mechanical system for height adjustment from 73 to 113 cm, by means of a special lever in reinforced nylon. **(1–2)**

Optional accessories

All models

– Cable slot in aluminium coloured polypropylene.
– Cable duct in black coated steel plate.
– Unit ready for connection to the electrical supply and LAN network. **(3)**
– Male/female 360° hooks in nylon for connecting seats. **(4-5)**

Hip-Up and Hip-Up T

– Modesty panel in white varnished steel sheet metal. **(6)**

IT

Materiali

Tutti i modelli

– Piano di scrittura in conglomerato ligneo bilaminato o melaminico con finitura anti-graffio e bordi in ABS, spessore 30 mm.

Hip-Up

– Trave portante in tubolare d'acciaio di sezione quadrata con struttura di sostegno in lamiera stampata. Gamba verniciata bianca in tubolare ellittico d'acciaio con tappi di copertura in polipropilene nero.

Hip-Up T

– Trave in tubolare d'acciaio a sezione rettangolare con struttura di sostegno in lamiera stampata, piegata e verniciata. Gamba verniciata bianca in tubolare rettangolare d'acciaio con tappi di copertura in polipropilene nero.

Hip-Up T-matic

– Trave in lamiera d'acciaio stampata, piegata e verniciata. Gamba verniciata bianca in tubolare quadrato d'acciaio con tappi di copertura in lamiera.

Tipologie di base

Tutti i modelli

– Ruote piroettanti con sistema di blocco a pedale a doppia carreggiata con battistrada in poliuretano.

Meccanismi

Hip-Up

– Sistema di ribaltamento del piano in acciaio trafilato con aggancio a molla e sgancio tramite apposite leve in polipropilene.

Hip-Up T e Hip-Up T-matic

– Sistema di ribaltamento del piano in acciaio trafilato con aggancio a molla e sgancio tramite apposite leve in polipropilene e regolatore di planarità del piano.

Hip-Up T-matic

– Sistema meccanico integrato di regolazione dell'altezza, da 73 a 113 cm, tramite apposita leva in nylon rinforzato. **(1–2)**

Accessori opzionali

– Vertebra passacavi in polipropilene color alluminio.
– Canaletta passacavi in lamiera d'acciaio verniciato nero.
– Predisposizione del piano per la connessione alla rete elettrica e alla rete LAN. **(3)**
– Ganci maschio/femmina 360° in nylon per collegamento piani. **(4-5)**

Hip-Up e Hip-Up T

– Modesty panel in lamiera d'acciaio verniciato bianco. **(6)**

FR

Matériaux

Tous les modèles

– Petit bureau en bois aggloméré mélaminé des deux côtés avec finition anti-rayures et bords en ABS, épaisseur 30 mm.

Hip-Up

– Poutre portante en tube d'acier à section carrée avec structure de support en tôle d'acier imprimée. Jambe vernie de

couleur blanche en tube d'acier à section elliptique avec bouchons de fermeture en polypropylène noir.

Hip-Up T

– Poutre en tube d'acier à section rectangulaire avec structure de support en tôle imprimée, pliée et vernie. Jambe vernie de couleur blanche en tube d'acier à section rectangulaire avec bouchons de fermeture en polypropylène noir.

Hip-Up T-matic

– Poutre en tôle d'acier imprimée, pliée et vernie. Jambe vernie de couleur blanche en tube d'acier à section carrée avec bouchons de fermeture en tôle.

Types de piètement

Tous les modèles

– Roulettes doubles pivotantes avec système de blocage à pédale avec chape en polyuréthane.

Mécanismes

Hip-Up

– Système de plan rabattable en acier étiré avec crochet à ressort et mécanisme de décrochage à l'aide de poignées spéciales en polypropylène.

Hip-Up T et Hip-Up T-matic

– Système de plan rabattable en acier étiré avec crochet à ressort et mécanisme de décrochage à l'aide de poignées spéciales en polypropylène et système régulateur de l'horizontalité du plan.

Hip-Up T-matic

– Système mécanique intégré de réglage de la hauteur, de 73 à 113 cm, à l'aide d'une poignée spéciale en nylon renforcé. **(1–2)**

Accessoires en option

– Vertèbre passe-câble en polypropylène couleur aluminium.
– Goulotte passe-câble en tôle d'acier verni noir.
– Réalisation du plan pour le raccordement au réseau électrique et au réseau LAN. **(3)**
– Crochets mâle/femelle 360° en nylon pour fixation des plans. **(4-5)**

Hip-Up et Hip-Up T

– Voile de fond Modesty en tôle d'acier verni blanc. **(6)**

DE

Materialien

Alle Modelle

– Schreibfläche aus Bilaminat-Schichtholz mit kratzfester Oberfläche und ABS-Kanten, Stärke 30 mm.

Hip-Up

– Stützbalken aus Stahlrohr mit quadratischem Querschnitt und Trägerkonstruktion aus gepresstem

Blech. Weiß lackiertes Bein aus elliptischem Stahlrohr mit schwarzen Abdeckkappen aus Polypropylen.

Hip-Up T

– Stützbalken aus Stahlrohr mit rechteckigem Querschnitt und Trägerkonstruktion aus gepresstem, gebogenem und lackiertem Blech. Weiß lackiertes Bein aus Vierkantstahlrohr mit schwarzen Abdeckkappen aus Polypropylen.

Hip-Up T-matic

– Balken aus gepresstem, gebogenem und lackiertem Stahlblech. Weiß lackiertes Bein aus quadratischem Stahlrohr mit Abdeckkappen aus Blech.

Grundmodelle

Alle Modelle

– Doppel-Lenkrollen mit Fußfeststellungssystem und Polyurethan-Lauffläche.

Funktionen

Hip-Up

– Kippsystem für die Arbeitsplatte aus gezogenem Stahl, mit Federaufhängung und -abhängung mittels spezieller Hebel aus Polypropylen.

Hip-Up T und Hip-Up T-matic

– Kippsystem für die Arbeitsplatte aus gezogenem Stahl mit Federaufhängung und -abhängung mittels spezieller Hebel aus Polypropylen und Regler für die Ebenheit der Arbeitsplatte.

Hip-Up T-matic

– Integrierte mechanische Höhenverstellung von 73 bis 113 cm mittels eines speziellen verstärkten Hebels aus Nylon. **(1–2)**

Sonderzubehörteile

– Kabelführung aus aluminiumfarbenem Polypropylen.
– Kabelkanal aus schwarz lackiertem Stahlblech.
– Vorbereitung der Arbeitsfläche für den Anschluss an Strom- und LAN-Netz. **(3)**
– 360° Nylon-Haken mit Außen- und Innengewinde für die Verbindung der Schreibplatten. **(4-5)**

Hip-Up und Hip-Up T

– Modesty-Panel aus weiß lackiertem Stahlblech. **(6)**



EN – Warranty IT – Garanzia
FR – Garantie DE – Garantie
ES – Garantía

ES

Materiales

Todos los modelos

– Plano de escritura en aglomerado de madera bilaminada con acabado resistente a los arañazos y bordes de ABS, espesor: 30 mm.

Hip-Up

– Viga portante en tubular de acero de sección cuadrada con estructura portante de chapa estampada. Pata pintada de blanco, en tubular elíptico de acero con tapas de polipropileno negro.

Hip-Up T

– Viga en tubular de acero de sección rectangular con estructura portante de chapa estampada, plegada y pintada. Pata pintada de blanco en tubular rectangular de acero con tapas de polipropileno negro.

Hip-Up T-matic

– Viga en chapa de acero estampada, plegada y pintada. Pata pintada de blanco, en tubular cuadrado de acero con tapas chapadas.

Tipos de base

Todos los modelos

– Ruedas giratorias de doble rodadura con banda de poliuretano y sistema de bloqueo de pedal.

Mecanismos

Hip-Up

– Sistema de superficie abatible en acero trafilado con enganche de muelle y desenganche mediante palancas de polipropileno.

Hip-Up T y Hip-Up T-matic

– Sistema de superficie abatible en acero trafilado con enganche de muelle y desenganche mediante palancas de polipropileno y regulador de la planitud de la superficie.

Hip-Up T-matic

– Sistema mecánico integrado para regular la altura, de 73 a 113 cm, mediante la palanca de nailon reforzado. **(1–2)**

Accesorios opcionales

– Vértebra pasacables de polipropileno color aluminio.
– Canaleta pasacables en chapa de acero pintada de negro.
– Preajuste del plano para la conexión a la red eléctrica y a la red LAN. **(3)**
– Enganches macho/hembra 360° de nailon para unir superficies. **(4-5)**

Hip-Up y Hip-Up T

– Panel Modesty en chapa de acero pintada de blanco. **(6)**

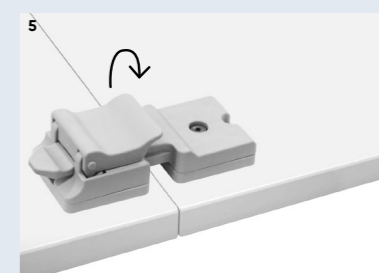
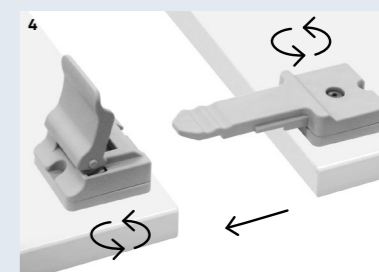
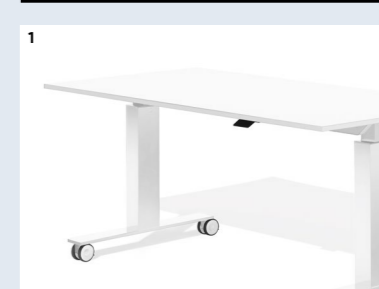

**Concept, art direction
and graphics**
Dogtrot

June 2022

aresline

Ares Line S.p.A.
via Brenta 7
36010 Carré VI Italy
T +39 0445 314931

aresline.com
fonology.it

